



Latitude

Shelving System Specification Guide

V1.02.03.18

The Latitude shelving system is a firm favourite with librarians and designers. Complete with the ability to customise components and accessories to fit your precise needs, this system is cost effective and will bring a touch of finesse to both traditional and contemporary interiors.

This stylish and versatile but affordable shelving system can be designed with maximum flexibility; using a wide range of finishes, end panels and sizes we can help you create a system that perfectly fits your space and requirements.



Sizes available

What's the difference?

Our reference size is the industry standard sizing for shelving, and makes ordering from us a lot simpler. Please use the reference size when placing your order.

The actual size is primarily for use by architects and designers who need exact measurements for drawings and site layouts.

Wall Freestanding

	Reference Size (mm)	Actual Size (mm)	
		Starter Bays	Add-On Bays
Height	2100	2120	2120
	1800	1820	1820
	1500	1520	1520
	1200	1220	1220
Width	1000	1062	1032
	900	962	932
	750	812	782
Depth	250	278	278
	300	328	328

Double Sided Island

	Reference Size (mm)	Actual Size (mm)	
		Starter Bays	Add-On Bays
Height	2100	2120	2120
	1800	1820	1820
	1500	1520	1520
	1200	1220	1220
			With Castors
	1500	1550	1550
	1200	1250	1250
Width	1000	1062	1032
	900	962	932
	750	812	782
Depth	250	526	526
	300	626	626

Elevations

Heights (mm)

Wall Freestanding

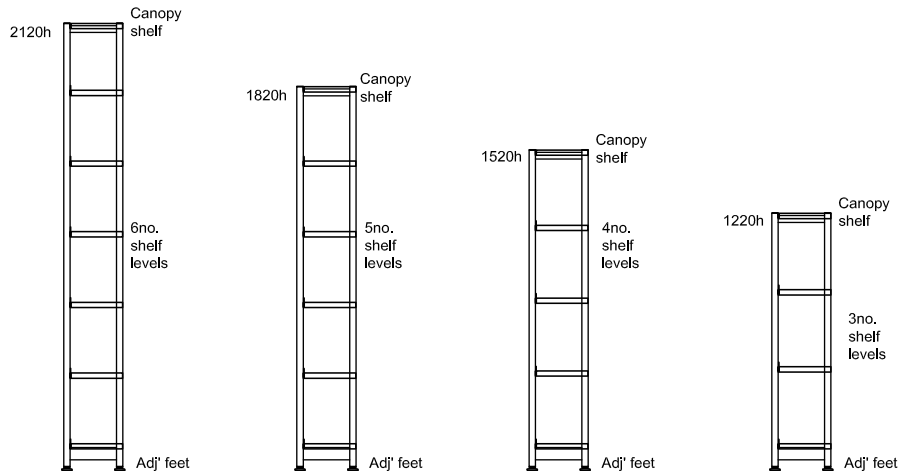

Double Sided Island

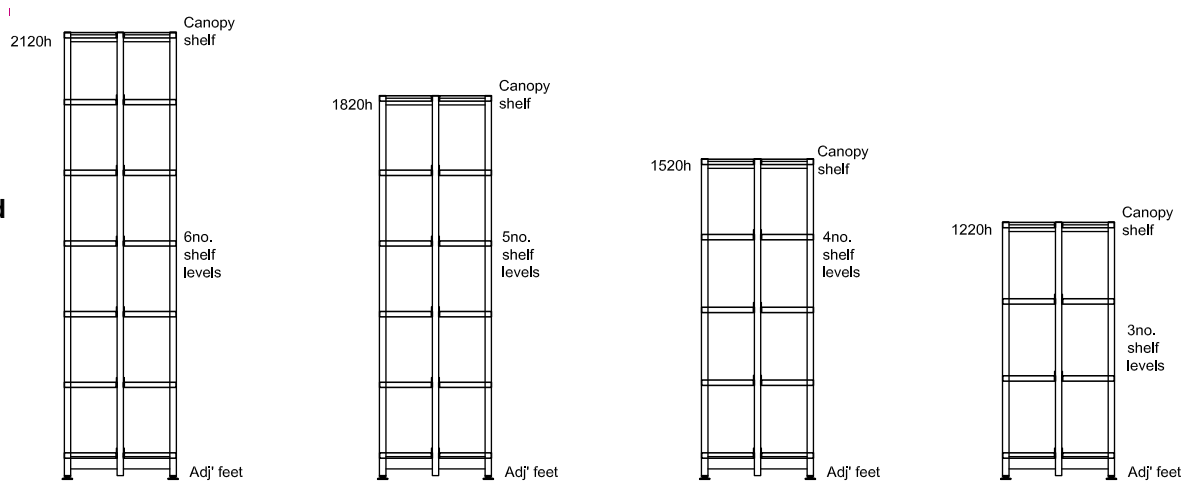

Double Sided Island with Castors

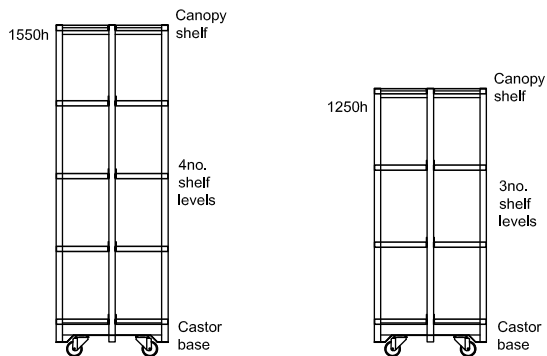

Please note:

- All shelves are shown 250mm deep. 300mm shelves are available.
- Levelling feet adjustment can add up to 15mm to the actual height of all Freestanding and Island units.

Plan View

Starter Bay Widths and Depths (mm)

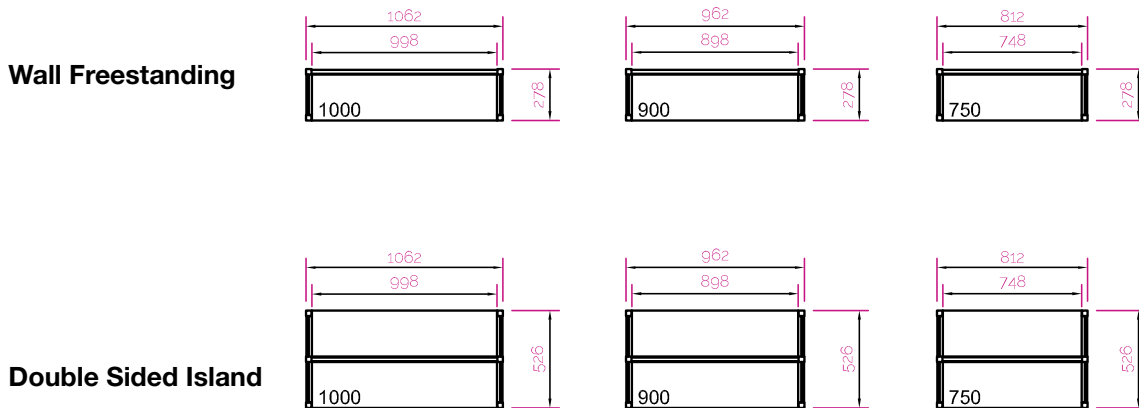

Add-On Bay Widths and Depths (mm)

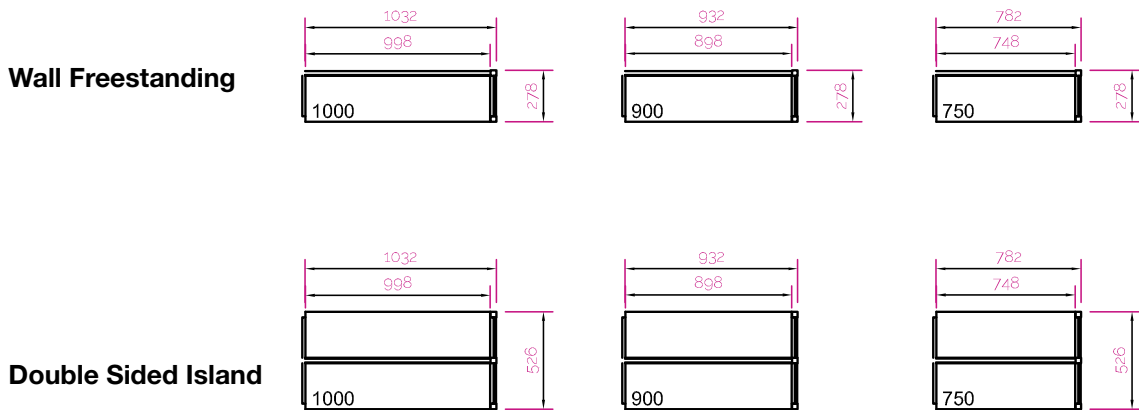

Accessories



Suspended Book Support

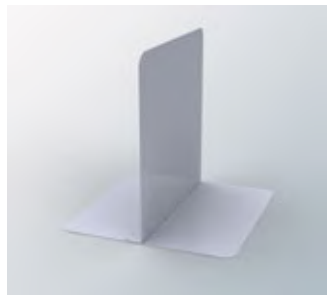

Magnetic Book Support



Conversion Bracket

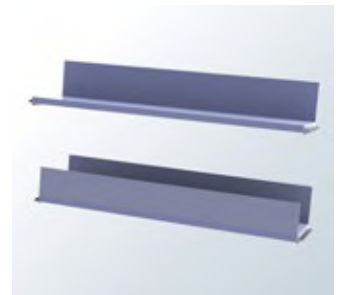

Multimedia Shelf



Bay Headers



Castor Frame

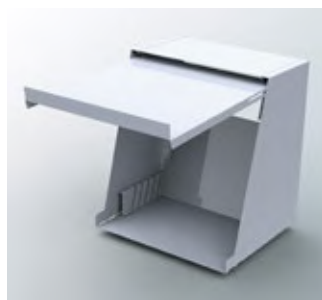

Display/Storage Box



End Table

End panel options



Plain MFC



Laminated



Wow Display Panel

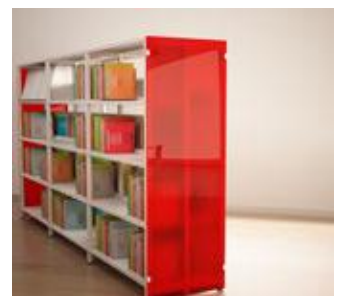

Acrylic



Steel Perforated



Steel Fully Perforated

Standard MFC Colours

More MFC colour options are available upon request



Maple
Egger H1521



Oak
Krono D687



Beech
Egger H1511



Walnut
Krono D481



White
Egger W1000



Light Grey
Egger U708



Silver
Egger F501



Graphite
Krono U164

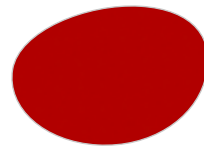

Red
Egger U321



Yellow
Egger U114



Blue
Egger U525



Sea Blue
Krono U3824

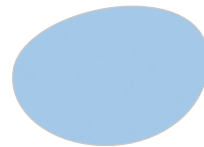

Caribbean
Krono U2510

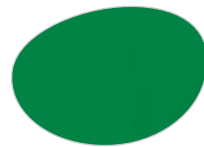

Emerald
Krono U155



Melon
Krono U4814

Premium MFC Colours

More MFC colour options are available upon request



Purple Jam
F Unilin U140



Lime Grass
Krono 5519

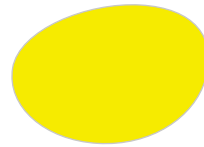

Saffron Yellow
Krono U2644



Flame Orange
Krono 7176

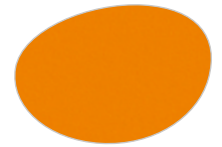

Jaffa
Krono U2645



Light Lilac
Krono U1254



Fuchsia
Egger U337



Mamara
Krono 5515



Mint
Krono U126



Petrol
Krono U4821

Steel Colours



White
RAL 9010



Light Grey
RAL 7035



Silver
RAL 9006



Anthracite Grey
RAL 7016

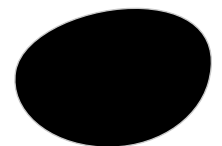

Black
RAL 9005

Important Note:

The printing process or computer screen cannot reproduce exactly the subtle colours, textures and finishes of the decor range.

Please review a sample prior to ordering.

Plain MFC end panels and Painted Steel shelving colours only.

Laminate and Acrylic end panel colours are available upon request due to quantity of options available.

20% premium charge for "Premium" colour options.



MEAHANDEL - Ein Geschäftsbereich der
MEAHANDEL Marketing GmbH

Brown-Boveri-Straße 6/17

2351 Wr. Neudorf

Telefon: +43 2236 374 032 14

Mobil: +43 699 14880014

email: astrid.pfeffer@mea-handel.com