



GAM
GONZAGARREDI
MONTESSORI





006 ACCOGLIENZA
RECEPTION

- 008** banco accoglienza
reception desk
- 016** lockers
lockers
- 020** comunicazione
communication



082 SPAZI PER RAGAZZI E BAMBINI
CHILDREN AND TEENS ENVIRONMENTS

- 084** scaffali, espositori, contenitori
shelves, displays, cabinets
- 092** tavoli e sedute
tables and chairs
- 098** pezzi speciali
special items
- 102** pedane, pouf, morbidi
stages, poufs, soft furnishings
- 110** sistema parete
wall system



026 EMEROTECA, AMBIENTI INFORMALI
NEWSPAPER LIBRARY, INFORMAL ENVIRONMENTS

- 028** espositori per riviste
magazine displays
- 034** sedute e tavoli informali
informal seats and tables



114 ABACHI SCAFFALI, CARTELLE COLORI
SHELVES CODIFICATION, COLOR CHARTS

- 124** abaco SISTEMA EPIFANO
EPIFANO SHELVING SYSTEM – item codes
- 128** cartelle colori
color charts



044 AMBIENTI PER CONSULTAZIONE, LETTURA, STUDIO
CONSULTATION, READING, STUDY AREAS

- 046** sistema MODULAR
MODULAR shelving system
- 060** sistema EPIFANO
EPIFANO shelving system
- 064** espositori per libri e supporti digitali
book and multimedia display units
- 068** tavoli per consultazione e lettura
consultation and reading tables
- 074** sedute lettura e multiuso
multipurpose and reading chairs
- 078** arredi fonoassorbenti
sound-absorbing furnishings



GAM
GAM

- 138** GAM biblioteche
GAM libraries
- 172** altri progetti GAM
other GAM projects
- 180** design GAM
GAM design
- 182** certificazioni
certifications



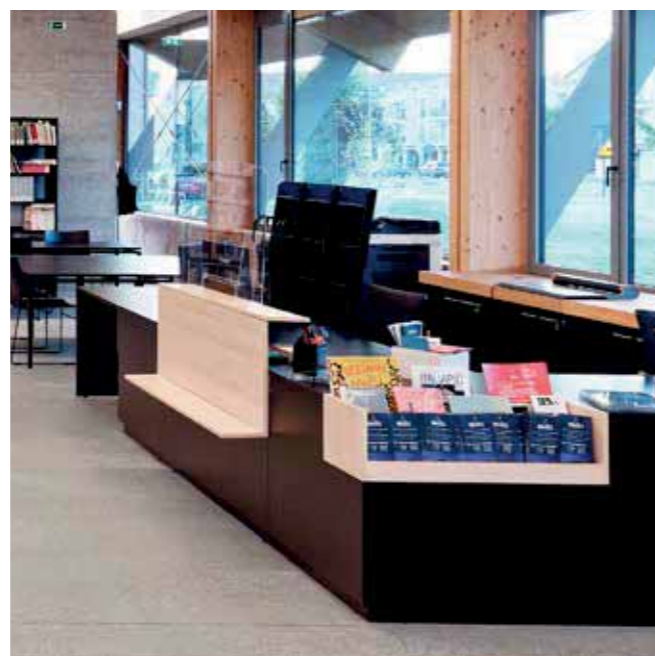

ACCOGLIENZA RECEPTION

La biblioteca si presenta. Invita a entrare, informa e guida. Lo spazio d'ingresso è significativo, attraente, amichevole. Non trasmette timore, dà il benvenuto. L'allestimento comunica a prima vista il carattere e le offerte della biblioteca. Il banco non è una barriera, suggerisce di avvicinarsi. Le pareti espongono novità e programmi, accolgono piccole mostre temporanee. Gli utenti capiscono come orientarsi e trovano contenitori dove riporre i loro oggetti, per muoversi liberamente tra gli ambienti della biblioteca.

The library introduces itself. It invites the community to enter, it informs and guides. The entrance space is not a barrier, it's attractive and welcoming. At first glance, the layout communicates the library character and offerings. The reception encourages the approach. The walls display news and programs, welcoming small temporary exhibitions. Users understand how to orient themselves and find lockers to store their belongings to move freely among the library environments.

BANCO ACCOGLIENZA RECEPTION DESK



Gli elementi modulari che compongono il sistema consentono di realizzare banchi diversi per forma, dimensione e dotazioni. Gli elementi principali compongono volume ad altezza tavolo: monolitico, minimale, monocromo. Al volume si aggiungono accessori: schermi, portaborse, espositori, contenitori, tavoli per consultazioni. Le composizioni giocano sul rapporto volume-accessori e sulla combinazione di due materiali o colori.

The modular elements that make up the reception system make it possible to create counters that differ in shape, size and equipment. The focus is on volume at table height: monolithic, minimalist, monochrome. The system comes with a wide range of accessories: grids, display stands, cabinets, consultation desks. The compositions balance volume, accessories, materials and colors combinations.

PERSONALIZZAZIONE CUSTOMIZATION

Una serigrafia permette di creare banchi di forte impatto estetico: la planarità delle superfici agevola l'applicazione di immagini o fotografie anche di grandi dimensioni.

A screen printing allows to create unique reception desks: the flat surfaces facilitate the application of images or pictures, even in large format.





COMPOSIZIONE LINEARE
linear configuration



COMPOSIZIONE CURVILINEA
curvilinear configuration



**COMPOSIZIONE AD ANGOLO
CON TAVOLO DI CONSULTAZIONE ALTO**
corner configuration with high desk



**COMPOSIZIONE A TRE LATI
CON ANGOLI STONDATI**
three-sided configuration
with rounded corners

COMPOSIZIONI LINEARI
LINEAR CONFIGURATIONS

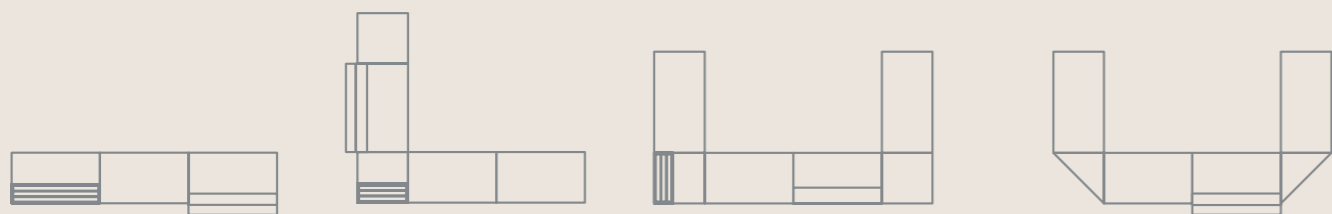

COMPOSIZIONI CURVILINEE
CURVILINEAR CONFIGURATIONS

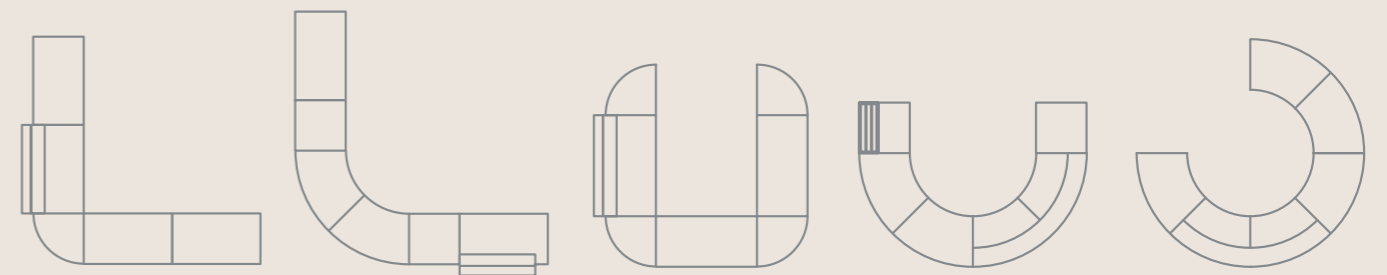



ACCESSORI

accessories

Contenitori chiusi ad ante e cassettiere completano le composizioni dei banchi per l'accoglienza.

Storage units and pedestals complete the reception desk configurations.



KUBIX

KUBIX

Poltroncina operativa con braccioli fissi, sedile e schienale imbottito. Regolazione manuale della seduta in altezza e in profondità. Base in nylon.

Task chair with fixed armrests, upholstered seat and back. Manual adjustment of the seat in height and depth. Nylon base.

61x55xh42/54 - 88/100 cm

GU0001179



KARMA

KARMA

Poltroncina operativa con braccioli regolabili, sedile imbottito e schienale in rete. Regolazione manuale della seduta in altezza e in profondità. Base in alluminio.

Task chair with adjustable armrests, upholstered seat and mesh backrest. Adjustable seat in height and depth. Aluminum base.

68x54xh42/54 - 100/113 cm

GC0003869



KORIUM MESH

KORIUM MESH

Poltroncina semidirezionale con braccioli, sedile imbottito e schienale alto in rete. Braccioli fissi in alluminio, imbottiti. Regolazione manuale della seduta in altezza e in profondità. Base in alluminio lucido.

Semi-executive armchair with armrests, upholstered seat and high mesh backrest. Fixed upholstered armrests in aluminum. Adjustable seat in height and depth. Polished aluminum base.

60x60xh42/54 - 110/122 cm

GC0005637

ACCOGLIENZA

RECEPTION



MODULO AUTONOMO
basic reception desk

80x120xh75 cm **GB0000050**
80x140xh75 cm **GB0000049**
80x160xh75 cm **GB0000045**

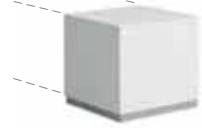

TERMINALE DESTRO
right end

80x40xh75 cm **GB0000001**
80x60xh75 cm **GB0000002**
80x80xh75 cm **GB0000003**
80x120xh75 cm **GB0000004**
80x140xh75 cm **GB0000005**
80x160xh75 cm **GB0000006**



TERMINALE SINISTRO
left end

80x40xh75 cm **GB0000011**
80x60xh75 cm **GB0000012**
80x80xh75 cm **GB0000013**
80x120xh75 cm **GB0000014**
80x140xh75 cm **GB0000015**
80x160xh75 cm **GB0000016**



PIANO CONSULTAZIONE BASSO
low desk

60x80xh75 cm **GB0000141**
60x120xh75 cm **GB0000142**
60x140xh75 cm **GB0000143**
60x160xh75 cm **GB0000144**
80x80xh75 cm **GB0000145**
80x120xh75 cm **GB0000146**
80x140xh75 cm **GB0000147**
80x160xh75 cm **GB0000148**



PIANO CONSULTAZIONE ALTO
high desk

60x80xh100 cm **GB0000151**
60x120xh100 cm **GB0000152**
60x140xh100 cm **GB0000153**
60x160xh100 cm **GB0000154**
80x80xh100 cm **GB0000155**
80x120xh100 cm **GB0000156**
80x140xh100 cm **GB0000157**
80x160xh100 cm **GB0000158**

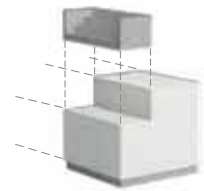

TERMINALE CON INCASSO DESTRO
right recessed end

80x80xh75 cm **GB0000063**

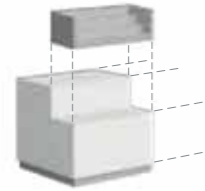

TERMINALE CON INCASSO SINISTRO
left recessed end

80x80xh75 cm **GB0000062**



TERMINALE CURVO DESTRO
right curved end

R100x80xh75 cm **GB0000031**
R100ex80xh75 cm **GB0000032**



TERMINALE CURVO SINISTRO
left curved end

R100x80xh75 cm **GB0000021**
R100ex80xh75 cm **GB0000022**



ESPOSITORE
display stand

60 cm **GB0000161**
80 cm **GB0000162**
120 cm **GB0000163**
140 cm **GB0000164**
160 cm **GB0000165**



RIALZO PORTABORSE
high bag-rack

80 cm **GB0000171**
120 cm **GB0000172**
140 cm **GB0000173**
160 cm **GB0000174**



VANO SCHERMO
straight top compartment

80 cm **GB0000181**
120 cm **GB0000182**
140 cm **GB0000183**
160 cm **GB0000184**



VANO SCHERMO ANGOLARE
corner top compartment

80x80 cm **GB0000185**



VANO SCHERMO CURVO
curved top compartment

R55x25 cm **GB0000195**
R155x25 cm **GB0000191**



INTERMEDIO
intermediate

80x80xh75 cm **GB0000041**
80x120xh75 cm **GB0000042**
80x140xh75 cm **GB0000043**
80x160xh75 cm **GB0000044**

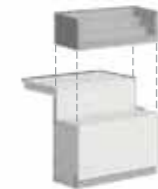

INTERMEDIO CON INCASSO
recessed intermediate

80x80xh75 cm **GB0000082**



INTERMEDIO CURVO
curved intermediate

R100x80xh75 cm **GB0000051**
R100ex80xh75 cm **GB0000033**

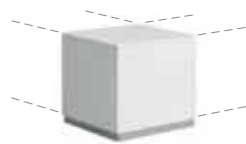

ANGOLO
corner

80x80xh75 cm **GB0000061**



CONTENITORE RETROBANCO
back desk cabinet

40x86,5xh75 cm **GB0000201**
40x96,5xh75 cm **GB0000202**
60x86,5xh75 cm **GB0000203**
60x96,5xh75 cm **GB0000204**
serratura/lock **GB0000216**



CONTENITORE RETROBANCO ANTE IN VETRO E SERRATURA
back desk cabinet with glass doors and lock

40x86,5xh75 cm **GB0000286**
40x96,5xh75 cm **GB0000287**
60x86,5xh75 cm **GB0000288**
60x96,5xh75 cm **GB0000289**



CASSETTIERA SU RUOTE
mobile pedestal

42x56xh58 cm **GB0000211**



PANNELLO SOSPESO
hanging panel

ml/m **GB0000231**

info

SCRITTA ADESIVA
adhesive writing

mq **GC0001520**

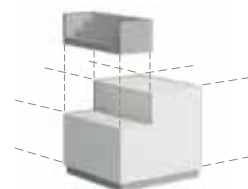

ANGOLO CON INCASSO DESTRO
right recessed corner

80x80xh75 cm **GB0000071**

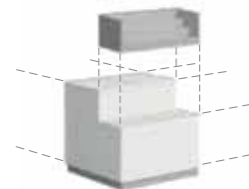

ANGOLO CON INCASSO SINISTRO
left recessed corner

80x80xh75 cm **GB0000081**



ANGOLO TRIANGOLO
triangle-shaped corner

80xh75 cm **GB0000091**



ANGOLO CURVO
curved corner

80xh75 cm **GB0000101**



BRACCIO PORTA MONITOR
monitor arm

GB0000253



PASSACAVI
cable port

Ø6 cm **GU0000098**



TOP ACCESS
top access

2 prese UNEL e 2 prese rete RJ45 **GB0000260**
4 prese UNEL e 2 prese rete RJ45 **GB0000267**



CANALINA CAVI
cable tray

80 cm **GC0001784**
120 cm **GC0001786**
140 cm **GC0001787**
160 cm **GC0001788**

LOCKERS

LOCKERS



Sistema di contenitori guardaroba con vani chiusi ad anta. Moduli di varie dimensioni sono aggregabili in linee da accostare a parete o in nuclei self standing. Ante di varie finiture consentono infinite composizioni.

Lockers with doors.
Modules of different sizes can be placed in row against the wall or in self-standing groups.
Various door finishes offer countless compositions.

DIMENSIONI

SIZES

Il sistema comprende moduli di due larghezze e tre altezze, composti da vani di tre differenti dimensioni.

Modules in two widths and three heights, made up of compartments in three different sizes.

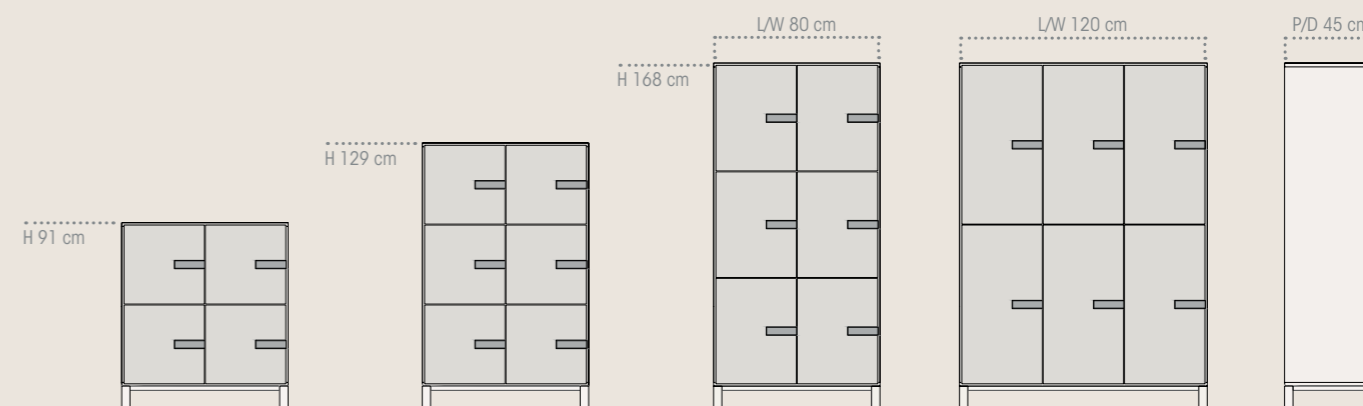



Le ante sono caratterizzate dal disegno essenziale delle maniglie lineari a incasso. Tutte le ante hanno serrature a chiave. Sono disponibili serrature a combinazione e lucchettabili.

The doors have ergonomic recessed handles and key locks. Padlockable and combination locks are also available.



SERRATURA A CHIAVE
key lock

GPN617000

PASSPARTOUT
master key

GPN617001

SERRATURA A COMBINAZIONE
combination lock

GPN617002

SERRATURA LUCCHETTABILE
padlockable lock

GPN617003

*lucchetto a parte
padlock not included

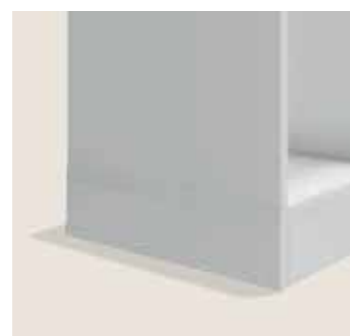
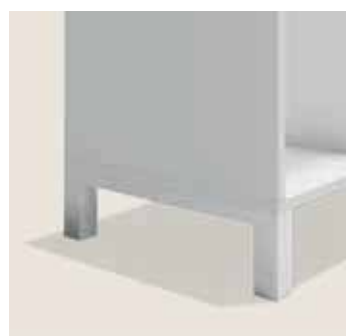

TELAIO SU PIEDI
frame on feet

45x45xh12 cm

GPN615000

TELAIO SU RUOTE
frame on castors

80x45xh12 cm

GPN615001

ZOCCOLO
plinth

GPN615010

GPN615011

GPN615020

GPN615021

120x45xh12 cm

GPN615002

GPN615012

GPN615022

La base dei contenitori è un telaio metallico su piedi o su ruote. Su richiesta può essere uno zoccolo in tinta.

The base of the cabinets is a metal frame on feet or castors. On request, the base can be a matching plinth.

CONTENITORI – VANO UTILE INTERNO | CABINETS – INTERNAL USABLE SPACE **H 36 37x42 cm**

L/W 80 cm

L/W 120 cm

CONTENITORE AD ANTE SINGOLE
single-door cabinet
H 91 cm
H 79 cm senza piedi | without feet



su piedi
on feet **GPN600600**
senza piedi
without feet **GPN600601**
su ruote
on castors **GPN600602**



su piedi
on feet **GPN610600**
senza piedi
without feet **GPN610601**
su ruote
on castors **GPN610602**

CONTENITORE AD ANTE SINGOLE
single-door cabinet
H 129 cm
H 117 cm senza piedi | without feet



su piedi
on feet **GPN601600**
senza piedi
without feet **GPN601601**
su ruote
on castors **GPN601602**



su piedi
on feet **GPN611600**
senza piedi
without feet **GPN611601**
su ruote
on castors **GPN611602**

CONTENITORE AD ANTE SINGOLE
single-door cabinet
H 168 cm



su piedi
on feet **GPN602600**



su piedi
on feet **GPN612600**

CONTENITORI – VANO UTILE INTERNO | CABINETS – INTERNAL USABLE SPACE **H 49 37x42 cm**

L/W 80 cm

L/W 120 cm

CONTENITORE SPOGLIATOIO AD ANTE SINGOLE
single-door closet
H 168 cm



su piedi
on feet **GPN612604**



su piedi
on feet **GPN612603**

CONTENITORI – VANO UTILE INTERNO | CABINETS – INTERNAL USABLE SPACE **H 74 37x42 cm**

L/W 80 cm

L/W 120 cm

CONTENITORE SPOGLIATOIO AD ANTE SINGOLE
single-door closet
H 168 cm



su piedi
on feet **GPN603000**



su piedi
on feet **GPN613000**

COMUNICAZIONE COMMUNICATION



PANNELLI AUTOPORTANTI BIFACCIALI

freestanding two-sided panels

Sistema di pannelli autoportanti in vari materiali e finiture, con struttura in acciaio su piedi o su ruote.

Freestanding panels in various materials and finishes, with steel structure on feet or wheels.

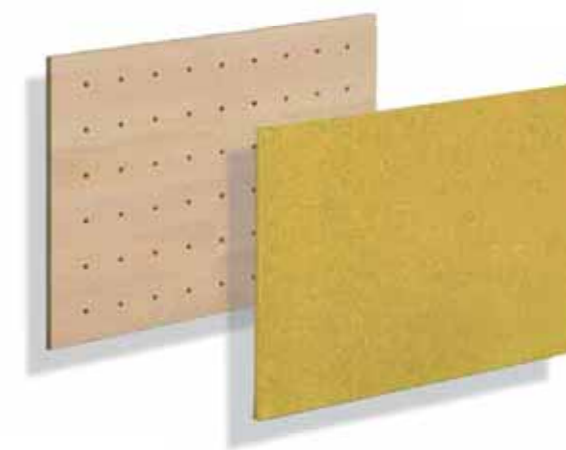

PANNELLI PER PARETI COMUNICATIVE

noticeboards for communication walls

Sistema di pannelli in vari materiali e finiture, da appendere a parete. Disponibili in più misure, coordinate per composizioni.

Noticeboards in various materials and finishes, to hang on the wall. Available in several sizes.

MATERIALI E COLORI

MATERIALS AND COLOURS

Pannelli lisci, con fori o fresature, in sughero, scrivibili neri o bianchi, magnetici, fonoassorbenti in molti colori.

Plain panels, with holes or slots, in cork, in black or white writeable HPL, magnetic, sound-absorbing in many different colors.





PANNELLO AUTOPORTANTE BIFACCIALE IN LEGNO FORATO
free-standing wooden noticeboard with holes

su piedi on feet **GP0909252**
su ruote on castors **GP0909253**

60x60xh168 cm



PANNELLO AUTOPORTANTE BIFACCIALE IN SUGHERO
free-standing cork noticeboard

su piedi on feet **GP0909254**
su ruote on castors **GP0909255**

60x60xh168 cm



PANNELLO AUTOPORTANTE BIFACCIALE IN LAMINATO BIANCO
free-standing white HPL writing board

su piedi on feet **GP0909256**
su ruote on castors **GP0909257**

60x60xh168 cm



PANNELLO IN LEGNO FORATO
wooden wall panel with holes

80xh77 cm
120xh77 cm

GP0945011
GP0945012



SCATOLA PER PANNELLO IN LEGNO FORATO
box for wooden noticeboard with holes

39x25xh26 cm

GP0944023



PANNELLO IN SUGHERO
cork wall panel

80xh77 cm
120xh77 cm

GP0945031
GP0945032



PANNELLO AUTOPORTANTE BIFACCIALE IN LAMINATO LAVAGNA
free-standing black HPL writing board

su piedi on feet **GP0909258**
su ruote on castors **GP0909259**

60x60xh168 cm



PANNELLO AUTOPORTANTE BIFACCIALE FONOASSORBENTE
free-standing sound-absorbing noticeboard

su piedi on feet **GP0909260**
su ruote on castors **GP0909261**

60x60xh168 cm



PANNELLO AUTOPORTANTE BIFACCIALE IN LEGNO CON GUIDE PER TASCHE*
free-standing wooden noticeboard with slots*

su piedi on feet **GP0909262**
su ruote on castors **GP0909263**

60x60xh168 cm



PANNELLO IN LAMINATO BIANCO
white HPL wall panel

80xh77 cm
120xh77 cm
120xh100 cm

GP0945041
GP0945042
GP0945054



PANNELLO IN LAMINATO LAVAGNA
black HPL writing board wall panel

80xh77 cm
120xh77 cm
120xh100 cm

GP0945051
GP0945052
GP0945053



PANNELLO FONOASSORBENTE
sound-absorbing wall panel

80xh77 cm
120xh77 cm

GP0945061
GP0945062



PANNELLO AUTOPORTANTE BIFACCIALE IN LEGNO CON GUIDE PER TASCHE E IN LAMINATO BIANCO*
free-standing white HPL and wooden noticeboard with slots*

su ruote on castors **GP0909269**

60x60xh168 cm



PANNELLO AUTOPORTANTE BIFACCIALE IN LEGNO CON GUIDE PER TASCHE E IN SUGHERO*
free-standing cork and wooden noticeboard with slots*

su ruote on castors **GP0909270**

60x60xh168 cm

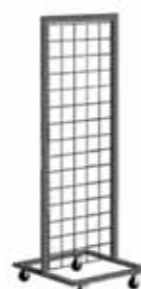

PANNELLO-GRIGLIA AUTOPORTANTE IN METALLO
free-standing metal grid

su piedi on feet **GP0909266**
su ruote on castors **GP0909267**

60x60xh168 cm



PANNELLO IN LEGNO CON GUIDE PER TASCHE*
wooden wall panel with slots*

80xh77 cm
120xh77 cm

GP0945021
GP0945022

*TASCA non inclusa
pocket not included

GC0001426



PANNELLO LIBRERIA A MURO
wall-mounted bookcase panel

100xh100 cm

GA0256909



PANNELLO-GRIGLIA CON TELAIO IN LEGNO
free-standing grid with wooden frame

60xh168 cm

GP0909268



**ESPOSITORE TOTEM
SU RUOTE A 5 RIPIANI**
5-shelf totem display on castors

75x75xh180 cm

GV000553



**ESPOSITORE TOTEM
SU RUOTE A 6 RIPIANI**
6-shelf totem display on castors

75x75xh210 cm

GV000554



**ESPOSITORE BIFACCIALE
SU RUOTE A 3/4 RIPIANI**
3/4-shelf double-sided display on castors

53x53xh150 cm
53x53xh175 cm

GB2E00B23
GB2E00C23



**CARRELLO PORTALIBRI A 4 RIPIANI
IN LEGNO CON STRUTTURA METALLICA**
book trolley with 4 inclined shelves

61x54xh141 cm

GB0Y00107



**CARRELLO PORTALIBRI A 3 RIPIANI
IN LEGNO E METALLO**
book trolley with 3 inclined metal shelves

74/94x42xh95 cm

GU0000133



**ESPOSITORE A PARETE PORTARIVISTE
A 4 RIPIANI**
4-shelf wall-mounted magazine display

45x15xh128 cm
60x15xh128 cm
90x15xh128 cm

GV0005547
GV0005548
GV0005549



**ESPOSITORE A PARETE PORTARIVISTE
A 5 RIPIANI**
5-shelf wall-mounted magazine display

45x15xh160 cm
60x15xh160 cm
90x15xh160 cm

GV0005550
GV0005551
GV0005552



**BOX RESTITUZIONE LIBRI
DA INTERNO**
indoor book return box

75x75xh95 cm

GV0001728



**BOX RESTITUZIONE LIBRI
DA ESTERNO 24H**
24h outdoor book return box

70x70xh118 cm
grafica | graphic design

GC0003530
GC0003675



**BOX DOPPIO RESTITUZIONE LIBRI
E MATERIALE MULTIMEDIALE
DA ESTERNO 24H**
24h outdoor book & multimedia return box

105x70xh118 cm
grafica | graphic design

GC0005656
GC0003675



EMEROTECA, AMBIENTI INFORMALI

NEWSPAPER LIBRARY, INFORMAL ENVIRONMENTS



La biblioteca è una piazza, aperta e vivace, dove corrono le informazioni. Un luogo che invoglia a trattenersi, liberamente, senza impegno.
L'emeroteca è lo spazio dell'attualità. Offre a tutti giornali e riviste del momento e conserva intere collezioni. Espone locandine di mostre e spettacoli e ogni informazione di comunità.
Contenitori per quotidiani e rotocalchi, espositori, tavoli e sedute informali allestiscono spazi amichevoli. Arredi flessibili supportano tecnologie per i nuovi modi di consultazione e lettura.

The library is a like lively square, a place that invites you to spend time freely.
 The newspaper library is the space of current events. It offers newspapers and magazines of the day and holds entire collections. It displays posters of exhibitions and shows and all community information.
 Display, tables and informal seats set up welcoming environments and hold multimedia for new ways of consulting and reading.

ESPOSITORI PER RIVISTE MAGAZINE DISPLAYS



GAM BOX GAM BOX

Sistema modulare di espositori-contenitori per riviste e libri.
L'elemento base è un cubo in metallo, contenitore da un lato,
espositore dall'altro.
Il sistema consente di comporre totem di varie altezze, pareti
di forma libera, sedute.

Modular system of display units/boxes for magazines and books.
The basic element is a metal cube which works as a box on one side
and display on the other.
The system allows to build totems, display walls, seats.



GAM BOX A PORTELLO FISSO
GAM BOX with door

32x32x32 cm

GB5000207



GAM BOX PASSANTE
open GAM BOX

32x32x16 cm

GB5000107



CARRELLO GAM BOX
GAM BOX trolley

64x64x7 cm

GB0E00128

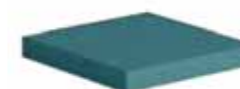

CUSCINO PER TORRE ESPOSITIVA
cushion for GAM BOX tower

64x64x8 cm

GAI000166



CUSCINO
cushion for GAM BOX row

32x96x5 cm

GAI201006



GRIGLIE E PANNELLI ESPOSITORI
display grids and panels

Espositori a parete e self standing.
Pannelli forati e griglie supportano accessori in metallo
e in plexiglas per mostrare libri e riviste.

Wall and freestanding displays.
Perforated panels and grids with metal and plexiglas accessories
for displaying books and magazines.



**ESPOSITORE IN METALLO FORATO
SU PANNELLO IN LEGNO**
metal perforated display on wooden panel

110x110 cm

GB0E00127



**GRIGLIA SELF STANDING
SU UN PIEDE E 2 RUOTE**
display grid on castors

95x53x175 cm

GB0E00225



GRIGLIA A PARETE
display grid

95x175 cm
kit di fissaggio a parete
wall fastening kit for display grid

GB0E00125

GB0E00725

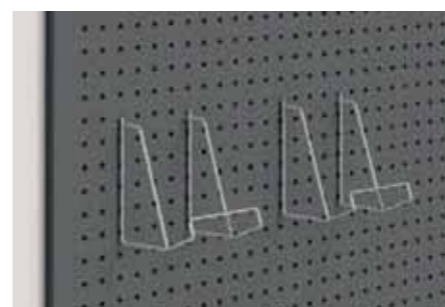

ESPOSITORE PLURIUSO – GAM 5
multipurpose display stand – GAM 5

**Elemento in tondino metallico
cromato, per esporre pubblicazioni
di piccole dimensioni.**

Display stand in chromed metal rod.

GB0E00010



ESPOSITORE UNIVERSALE PER LIBRI, GIORNALI, RIVISTE – GAM 6
book, newspapers and magazine display stand – GAM 6

**Supporto multifunzione in tondino metallico cromato, utilizzabile
in tre diverse posizioni: inclinata, orizzontale e a cestello.**

Multipurpose display stand in chromed metal rod. It can be used in three different
positions: inclined, horizontal and basket.

GB0E00011



ESPOSITORE IN PLEXIGLAS – GAM 7
plexiglas display stand – GAM 7

**Tasca per l'esposizione temporanea
di quotidiani e volumi di piccole
dimensioni.**

Display pocket for newspapers
and small books.

GB0E00004



PIANO INCLINATO – GAM 8
inclined shelf – GAM 8

**Espositore in metallo inclinato,
per esporre frontalmente riviste, volumi
chiusi o aperti e ogni pubblicazione
che necessita di una superficie
di supporto di grandi dimensioni.**

Inclined metal display to show magazines
frontally, closed or open volumes
and any publication that requires a large
support surface.

GB0E00001



PIANO ORIZZONTALE – GAM 9
horizontal display stand – GAM 9

**Espositore orizzontale per volumi
e supporti digitali.**

Horizontal display stand for volumes
and multimedia.

GB0E00002



GREEN FRAME
GREEN FRAME

Sistema di telai spaziali per contenere ed esporre libri e oggetti insieme a piante in vaso. La struttura in alluminio e gli accessori in legno naturale consentono infinite composizioni.

Frame system for holding and displaying books and objects together with potted plants. The aluminum structure and natural wood accessories allow to build countless compositions.

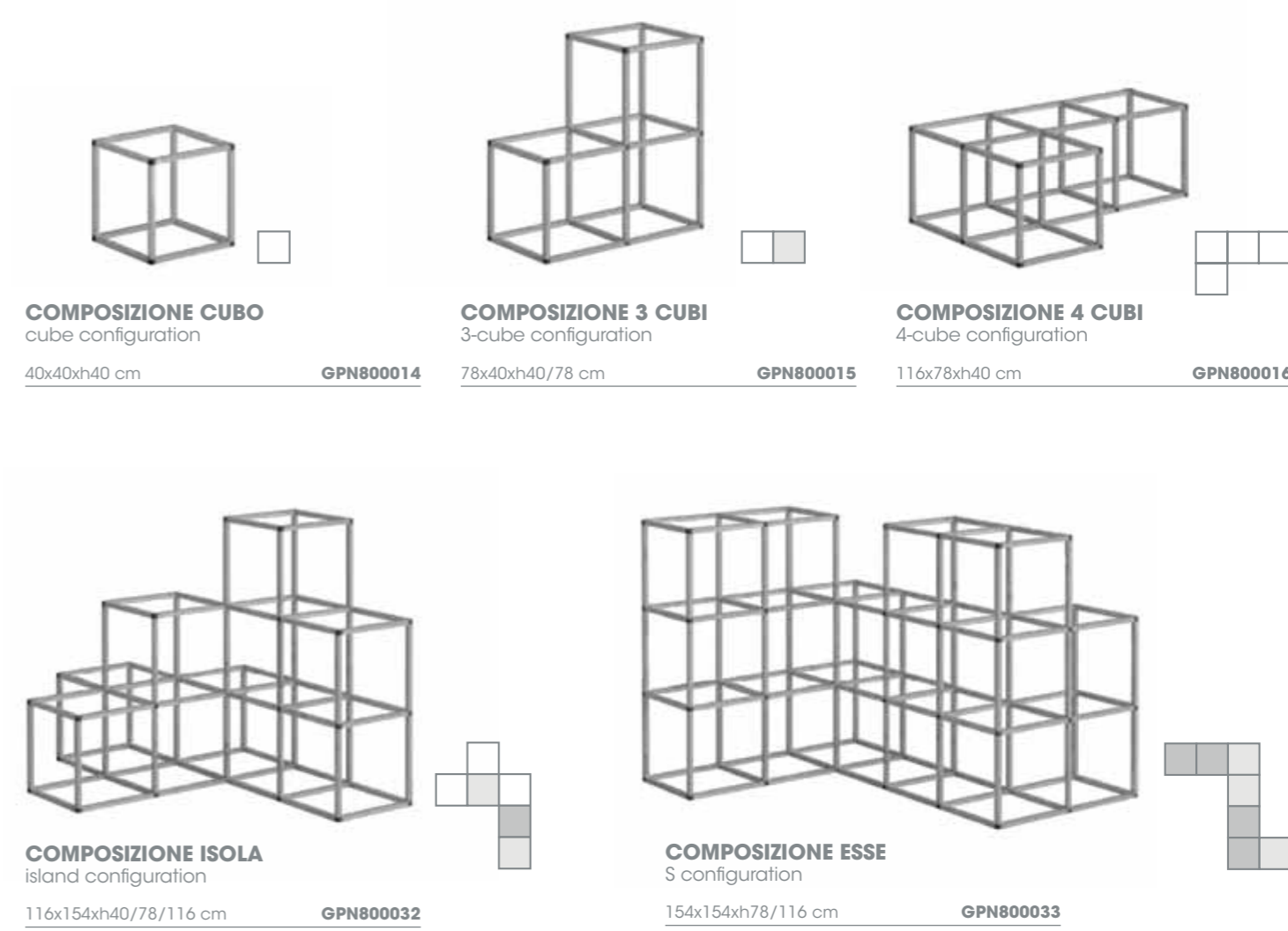

COMPONENTI
COMPONENTS

GREEN FRAME è composto da pochi semplici elementi: barre di tubolare quadro in alluminio di un'unica lunghezza e nodi in plastica di quattro tipi.

GREEN FRAME is made of a few, simple elements: square tubular aluminum bars of a single length and plastic nodes of four types.

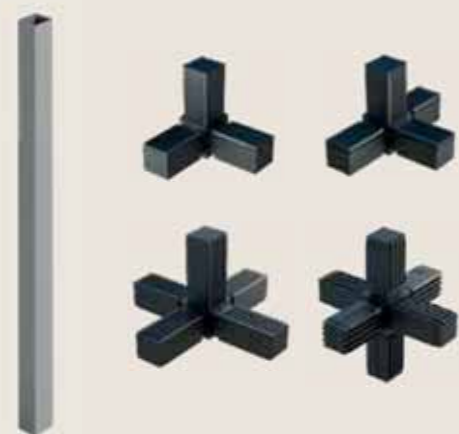

PIANO PORTALIBRI
bookshelf
38x38x13 cm **GPN800035**



MEZZO PIANO
shelf
38x19 cm **GPN800000**



PIANO FORATO PORTAVASI
preforated pot holder
38x38 cm **GPN800001**



CONTENITORE
tray
38x38x10 cm **GPN800002**



CONTENITORE PORTALIBRI
bookcase
38x38x13 cm **GPN800036**



BASE SU RUOTE
castor base
38x38x10,5 cm **GPN800005**
76x38x10,5 cm **GPN800007**



CUBO MORBIDO
soft cube
35x35x35 cm **GAI208004**

SEDUTE E TAVOLI INFORMALI INFORMAL SEATS AND TABLES

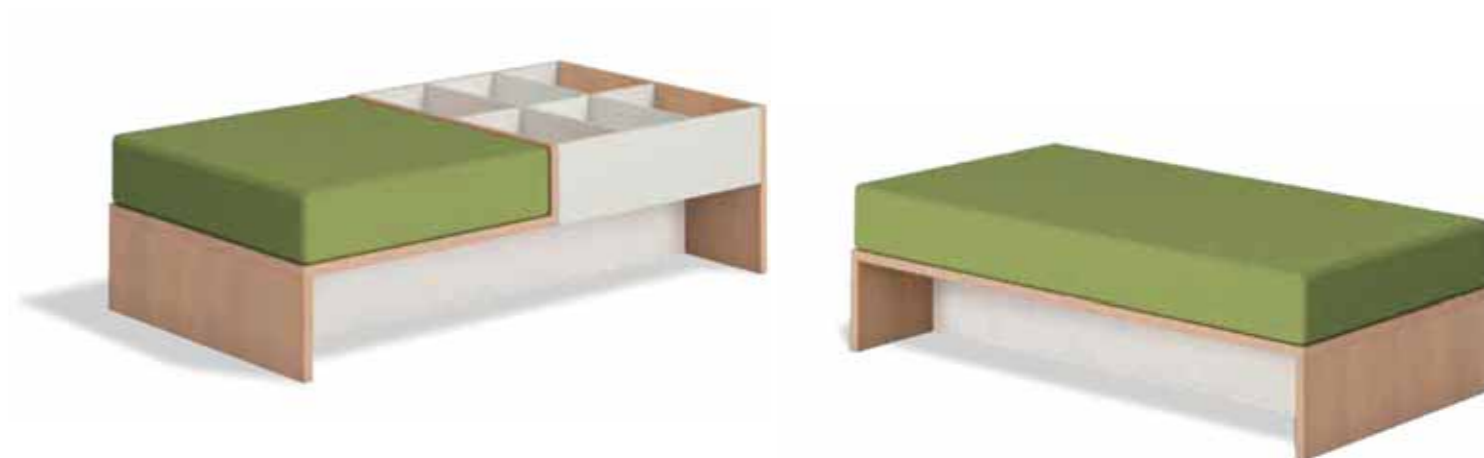

SISTEMA PANCHE ELLE
ELLE benches

Sistema composto da panche in legno dal design essenziale, che possono essere completate da cuscini e affiancate da contenitori a caselle per libri. Componibile, aggregabile, modulare, per formare isole o ampie zone di lettura.

System of wooden benches with an essential design, which can be completed with cushions and placed next to bookcases. Modular items to create islands or large reading areas.



PANCA ELLE
ELLE bench

160x80xh44 cm

GC0001061



PANCA ELLE CON CONTENITORE A 6 CASELLE
ELLE bench with 6-compartment book browser

160x80xh44 cm

GC0001062



PANCA ELLE CON CUSCINO
ELLE bench with upholstered cushion

160x80xh44 cm

GC0001064

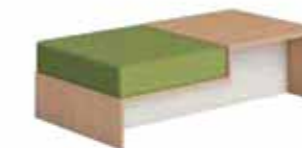

PANCA ELLE CON MEZZO CUSCINO
ELLE bench with half upholstered cushion

160x80xh44 cm

GC0001065

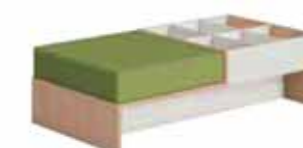

PANCA ELLE CON CUSCINO E CONTENITORE A 6 CASELLE
ELLE bench with upholstered cushion and 6-compartment book browser

160x80xh44 cm

GC0001066

EMEROTECA, AMBIENTI INFORMALI

NEWSPAPER LIBRARY,
INFORMAL ENVIRONMENTS



COMPOSIZIONE LINEARE
linear configuration

BUKSOFA BUKSOFA

Sistema di elementi in legno e imbottiti, per comporre pouf, poltrone, divani. Pochi elementi consentono di realizzare infinite composizioni: lineari mono e bifronte, ad angolo, a isola. Le basi con vani aperti contengono libri.

System of wooden and upholstered items to compose poufs, armchairs, sofas.
Few elements allow you to create linear, single-sided, double-sided, corner, island compositions.
The open bases hold books.



COMPOSIZIONE AD ANGOLO
corner configuration



BASE
base

60x60xh29 cm
60x75xh29 cm
75x75xh29 cm

GP0909290
GP0909291
GP0909292



BASE PORTALIBRI
bookcase base

60x60xh29 cm

GP0909293



SCHIENALE
backrest

60x15xh66 cm

GP0909294



SCHIENALE PORTALIBRI
bookcase backrest

60x15xh66 cm

GP0909295



CONTENITORE
bookcase

60x60xh29 cm
60x75xh29 cm

GP0909296
GP0909297



CUSCINO SEDUTA
seat cushion

60x60xh9 cm
60x75xh9 cm
75x75xh9 cm

GAI239005
GAI239006
GAI239007



CUSCINO SCHIENALE
backrest cushion

60x15xh28 cm

GAI239008

COMPOSIZIONI CONFIGURATIONS





POLTRONCINA KUARK
KUARK armchair

67x57xh44/78cm

GC0001326



CUSCINO REMOVIBILE E SFODERABILE
cushion with removable fabric

41x44 cm

GC0001327

KUARK
KUARK

Poltroncina a pozzetto in polietilene non poroso, per utilizzo in interno e in esterno.
Disponibile in varie colorazioni, può essere dotata di cuscino removibile.

Tub armchair in non-porous polyethylene, for indoor and outdoor use. Available in various upholsteries, it can be equipped with a removable seat cushion.



POLTRONA MIT CON SCHIENALE BASSO, BASE A 4 GAMBE IN FAGGIO NATURALE
MIT armchair with low backrest, natural beech 4-leg base

80x82xh42/77 cm

GC0005602



POLTRONA MIT CON SCHIENALE BASSO, BASE A SLITTA
MIT armchair with low backrest, sled base

80x82xh42/77 cm

GC0005355

MIT
MIT

Poltrona disponibile con schienale basso o alto, con gambe in faggio naturale o con base a slitta.
Personalizzabile con tessuti a contrasto tra scocca e cuscini.

Armchair with low or high backrest, on natural beech legs or sled base. Customizable with contrasting fabrics.



POLTRONA TONA CON SCHIENALE ALTO, BASE A 4 GAMBE IN FAGGIO NATURALE
TONA armchair with high backrest, natural beech 4-leg base

77x77xh42/110 cm

GU0002819



POLTRONA TONA CON SCHIENALE ALTO, BASE A 4 GAMBE IN FAGGIO VERNICIATO NERO
TONA armchair with high backrest, black beech 4-leg base

77x77xh42/110 cm

GU0002812

TONA
TONA

Poltrona dalle linee morbide. Sedile interamente stampato in poliuretano schiumato a freddo. Struttura della scocca in acciaio. Lo schienale alto con risvolti laterali garantisce un ottimo comfort.

Armchair with a sinuous design. Seat entirely molded in cold-foamed polyurethane. Steel shell structure. The high backrest with side flaps offer an excellent comfort.



POLTRONA MIT CON SCHIENALE ALTO, BASE A 4 GAMBE IN FAGGIO NATURALE
MIT armchair with high backrest, natural beech 4-leg base

80x82xh42/103 cm

GC0005606



POLTRONA MIT CON SCHIENALE ALTO, BASE A SLITTA
MIT armchair with high backrest, sled base

80x82xh42/103 cm

GC0005354



POLTRONA TONA CON SCHIENALE ALTO, BASE A SLITTA
TONA armchair with high backrest, sled base

77x77xh42/110 cm

GU0002803





**POLTRONA KENDO MONOCOLORE
CON SCHIENALE BASSO E BRACCIOLI**
KENDO armchair with low backrest,
one-color

78x69xh45/73 cm

GC0003868



**POLTRONA KENDO BICOLORE
CON SCHIENALE BASSO E BRACCIOLI**
KENDO armchair with low backrest,
two-color

78x69xh45/73 cm

GC0003756

KENDO
KENDO

Sistema di sedute imbottite composto da poltrone e pouf, su base a 4 piedi in acciaio verniciato. Le poltrone possono avere schienale basso o alto, con rivestimento monocolore o bicolore. Tutti gli elementi possono essere accessoriati con doppia presa USB.

Upholstered seating system composed of armchairs and poufs, on painted steel legs. The armchairs can have a low or high backrest, with one-color or two-color upholstery. All elements can be equipped with a double USB socket.



POLTRONCINA KUAD
KUAD armchair

65x56xh49/82 cm

GC0002303

KUAD
KUAD

Poltroncina con schienale flessibile, imbottito, con tessuto monocolore, con base a slitta.

Armchair with flexible backrest and one-color upholstery, on sled base.



POUF KENDO BICOLORE
KENDO POUF, two-color

67x63xh46 cm

GC0002559



**POLTRONA KENDO BICOLORE
CON SCHIENALE ALTO**
KENDO armchair with high backrest,
two-color

90x73xh46/127 cm

GC0002558



**SISTEMA DI CABLAGGIO KENDO/KONTEX
CON DOPPIA PRESA USB**
KENDO/KONTEX wiring system
with double USB socket

GC0005107



POLTRONCINA KICCA PLUS
KICCA PLUS armchair

53x57xh46/78 cm

GC0005692

KICCA PLUS
KICCA PLUS

Poltroncina monoscocca imbottita, con base a 4 gambe.

Upholstered monocoque armchair, 4-leg base.



DIVANO KONTEX BICOLORE 2 POSTI
KONTEX two-seater sofa, two-color

140x70xh44/47 cm

GC0002803



COMPOSIZIONE KONTEX 2+2
KONTEX configuration 2+2

238x140xh128 cm

GC0003871

KONTEX
KONTEX

Divani disponibili con schienale basso o alto, con rivestimento monocolore o bicolore, con piedi di colore bianco. Possono essere accessoriati con doppia presa USB.

Sofas with one-color or two-color upholstery, on white 4-foot base. All elements can be equipped with a double USB socket.



TAVOLINO KALEOX TONDO
KALEOX round small table

Ø60xh40 cm bianco | white
Ø60xh40 cm nero | black

GC0000550
GC00003917



TAVOLINO KALEOX QUADRATO
KALEOX square small table

60x60xh40 cm bianco | white
60x60xh40 cm nero | black

GC00003916
GC0000609

KALEOX
KALEOX

Tavolini multiuso con base in acciaio e piano in HPL. Disponibili in colore bianco o nero.

Multipurpose small tables with steel base and HPL top. Available in white or black color.



KENSHO
KENSHO

Sistema di tavolini e pouf di forma triangolare arrotondata. I pouf sono disponibili con rivestimento monocolor o bicolore.

Small tables and poufs with rounded triangular shape. The poufs are available with one-color or two-color upholstery.



POUF KENSHO MONOCOLORE
KENSHO pouf, one-color

55/37xh51 cm **GC0005639**
65/70xh42 cm **GC0005640**
76/88xh42 cm **GC0005641**



POUF KENSHO BICOLORE
KENSHO pouf, two-color

55/37xh51 cm **GC0003862**
65/70xh42 cm **GC0003861**
76/88xh42 cm **GC0003911**



TAVOLINO KENSHO, BASE IN TONDINO
KENSHO small table, rod base

L/W53 45xh46 cm **GC0003336**
L/W53 45xh54 cm **GC0005388**



TAVOLINO KENSHO, BASE CIRCOLARE
KENSHO small table, round base

L/W53 Ø41xh46 cm **GU0000502**
L/W53 Ø41xh53 cm **GU0000503**
L/W80 Ø48xh75 cm **GC0002131**
L/W53 Ø48xh110 cm **GC0005389**
L/W70 Ø48xh110 cm **GU0001309**

MANTRA
MANTRA

Pouf cilindrici di vari diametri, con struttura in legno, con piedini antiscivolo regolabili.

Cylindrical poufs of various diameters, with wooden structure and adjustable non-slip feet.



POUF MANTRA
MANTRA pouf

Ø40xh45 cm **GC0005481**
Ø70xh45 cm **GC0005483**



POUF POINT
POINT pouf

Ø58xh50 cm **GC0005272**
Ø60xh43 cm **GC0005129**
Ø85xh43 cm **GC0005273**
Ø125xh43 cm **GC0005271**

POINT
POINT

Pouf tondi dalla linea morbida, di vari diametri e altezze, con piedini regolabili.

Round poufs of various diameters and heights, with adjustable feet.



POUF POINT Q
POINT Q pouf

45x45xh40 cm **GU0002030**
90x45xh40 cm **GU0002031**
90x45xh65 cm **GU0002032**
90x90xh40 cm **GU0002033**

SISTEMA DI CABLAGGIO CON 2 USB
wiring system with double USB socket

Ø4,2 cm **GU0002034**

POINT Q
POINT Q

Pouf quadrati e rettangolari dalla linea morbida, di varie dimensioni, con piedini regolabili. Possono essere accessoriati con doppia presa USB.

Square poufs of various sizes, with adjustable feet. They can be equipped with a double USB socket.



POUF TRIO
TRIO pouf

170x150xh44 cm **GC0005137**

TRIO
TRIO

Grande pouf di forma trilobata, con struttura molto resistente e cuciture con supporti in fibra di carbonio.

Large three-lobed pouf, with a very resistant structure and internal supports in carbon fibre.

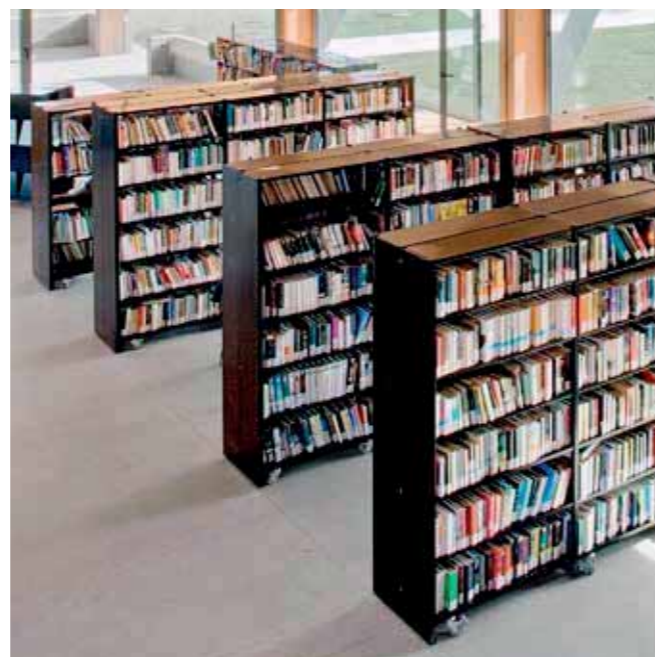

AMBIENTI PER CONSULTAZIONE, LETTURA, STUDIO

CONSULTATION, READING, STUDY AREAS

La biblioteca ha un cuore pieno di libri, trasmette il desiderio di leggere pagine di carta. Libri a fianco di dotazioni digitali, nella grande rete che lega mille biblioteche. La biblioteca è sempre un ponte tra conservazione e innovazione. Ambienti moderni sostengono ogni forma di consultazione, lettura e studio. Lo spazio è organizzato in aree tematiche, flessibili, riconfigurabili. Gli arredi raccolgono ed espongono volumi e supporti multimediali. Sono disposti per definire ambiti protetti e aperti, formali e informali.

The library has a heart full of books, it conveys the desire to read paper pages. Printed books and digital equipment together, in the great cultural network that connects thousands of libraries. The library is the bridge between conservation and innovation. Modern environments promote consultation, reading and study. The space is organized into thematic, reconfigurable areas. The furnishings collect and display volumes and multimedia supports, defining formal and informal environments.

AMBIENTI PER
CONSULTAZIONE,
LETTURA, STUDIO

CONSULTATION,
READING, STUDY AREAS

SISTEMA EPIFANO EPIFANO SHELVING SYSTEM



EPIFANO è un sistema semplice e funzionale. Fianchi a pannello pieno in nobilitato supportano piani in lamiera d'acciaio. Il design essenziale è arricchito dalla dotazione di accessori.

EPIFANO is a simple and functional shelving system made of MFC end panels and steel sheet shelves. The essential design is enriched by the range of accessories.

DIMENSIONI

SIZES

IL SISTEMA EPIFANO comprende moduli mono e bifronte di cinque altezze e due larghezze.

EPIFANO SYSTEM includes single and double-sided shelves available in five heights and two widths.

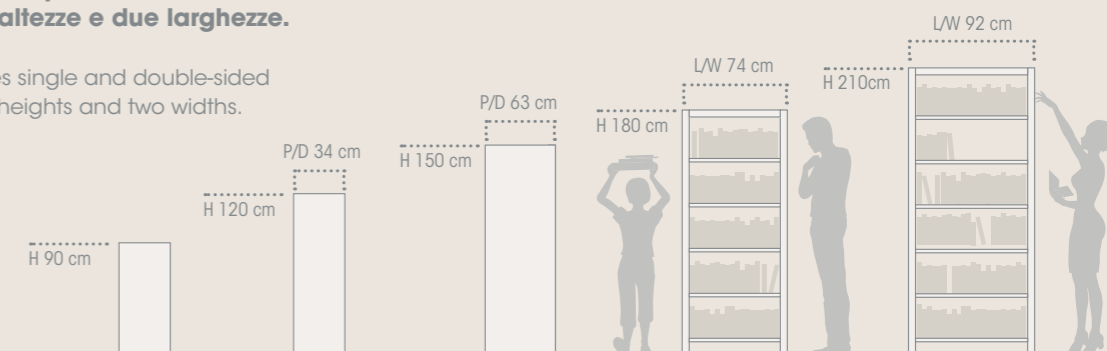



ANTE
doors

EPIFANO può essere dotato di ante, basse o alte, in legno o in vetro.

EPIFANO shelf can be equipped with high or low doors, in wood or glass.



FIANCO ESPOSITORE
side display

Al fianco di testata dello scaffale bifronte può essere fissato uno speciale modulo espositore.

A special display module can be fixed to the side of the double-sided shelf.

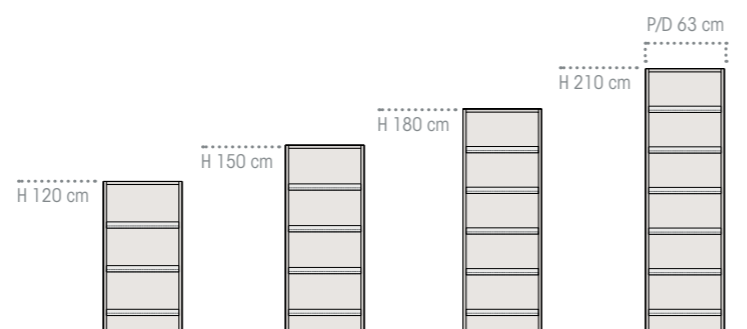

Alla base dello scaffale EPIFANO possono essere inserite ruote o zoccoli frontali.

Castors or front plinths can be inserted at the base of the EPIFANO shelf.



ACCESSORI PER FIANCHI
SIDE ACCESSORIES



PIANO DI CONSULTAZIONE
fixed consultation shelf

GB6R00450

ACCESSORI PER RIPIANI
SHELF ACCESSORIES



ESPOSITORE TRE VANI PER RIVISTE
3-compartment magazine display box

87x38x36 cm
coppia staffe | brackets

GB6E02831
GB6R01430



CONTENITORE ESTRAIBILE
pull-out media drawer

87x25 cm

GB0CCA009

Su EPIFANO è possibile usare anche gli accessori MODULAR:

It is also possible to use the MODULAR accessories on EPIFANO shelf:

- **DOCK MULTIMEDIALE**
multipurpose dock
GB0C00101
- **ESPOSITORE PLURIUSO – GAM 4**
multipurpose display stand – GAM 4
GB0E00003
- **ESPOSITORE PLURIUSO – GAM 5**
multipurpose display stand – GAM 5
GB0E00010

FERMALIBRI
BOOK SUPPORT



FERMALIBRO A MEZZALUNA
semicircular book support

GB0F00106

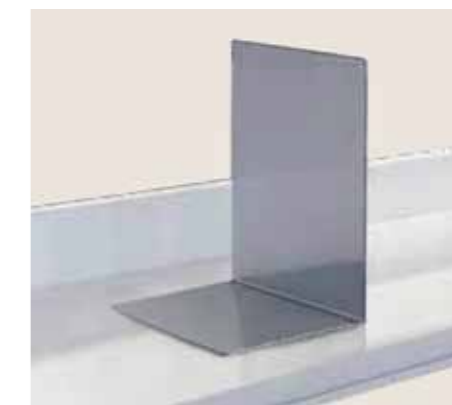

FERMALIBRO A L
L-shaped book support

GB4M10251

SEGNALETICA
SIGNAGE



GB0D00411



SEGNALETICA DI PIANO
front clip-on label for canopy

GB0E00115

ESPOSITORI PER LIBRI E SUPPORTI DIGITALI BOOK AND MULTIMEDIA DISPLAY UNITS



SISTEMA INSERT INSERT SYSTEM

Sistema per realizzare librerie con box espositivi e altri accessori. Contenitori a giorno o chiusi, con ante o cassetti, si inseriscono nei vani dello scaffale per comporre mosaici di vari materiali e colori.

Modular system to create bookcases with display boxes and other accessories. Open or closed cabinets, with doors or drawers, fit into the shelf compartments to compose mosaics of various materials and colors.



SCAFFALE INSERT
INSERT bookcase

169x40xh197 cm

G1V10092N

SCHIENALE
back

80xh45 cm

G1V10195N

BOX FILL
FILL box

40x38xh45 cm
40x38xh45 cm

G1V10194L
G1V10194N



CONTENITORE A GIORNO FILL
FILL open cabinet

40x40xh45 cm
40x40xh45 cm
80x40xh45 cm
80x40xh45 cm

G1V10179L
G1V10179N
G1V10086L
G1V10086N



CASSETTIERA FILL
FILL drawer unit

80x40xh45 cm
80x40xh45 cm

G1V10084L
G1V10084N



CONTENITORE CON ANTE FILL
FILL cabinet with doors

40x40xh45 cm destro | right
40x40xh45 cm destro | right
40x40xh45 cm sinistro | left
40x40xh45 cm sinistro | left
80x40xh45 cm
80x40xh45 cm

G1V10181L
G1V10181N
G1V10180L
G1V10180N
G1V10088L
G1V10088N



ESPOSITORE A SCHEDARIO
9-compartment book browser

96x60xh90 cm

GB0000414



**ESPOSITORE A SCHEDARIO
CON TRE VANI VERTICALI**
15-compartment book browser

96x60xh90 cm

GB0000415



ESPOSITORE CASSETTO SU RUOTE
9-compartment drawer on castors

90x60xh30 cm

GB0000416



**ESPOSITORE A SCHEDARIO
CON TRE VANI VERTICALI SU RUOTE**
15-compartment book browser cart

96x60xh75 cm

GB0000413



ESPOSITORE A SCHEDARIO SU RUOTE
8-compartment book browser cart

60x60xh60 cm
60x60xh80 cm

GV0001661
GV0001662



**ESPOSITORE A SCHEDARIO
CON CASSETTO**
BOOK BROWSER WITH DRAWER

**Il cassetto su ruote può essere
inserito nell'espositore o essere
usato separatamente.**

The drawer can be placed in the book
browser or used separately.



**ESPOSITORE A SCHEDARIO
CON STRUTTURA METALLICA**
9-compartment book browser on metal frame

96x60xh75 cm

GV0002705



**ESPOSITORE A SCALARE
CON STRUTTURA METALLICA**
book browser on metal frame – for display
and storage

96x60xh100 cm

GV0001788

TAVOLI PER CONSULTAZIONE E LETTURA CONSULTATION AND READING TABLES



TAVOLO IDEA+
IDEA+ table

80x60xh76 cm
100x60xh76 cm
120x60xh76 cm
140x60xh76 cm
160x60xh76 cm
180x60xh76 cm

GU0000216
GU0000217
GU0000510
GU0000501
GU0000470
GU0000219

80x80xh76 cm
100x80xh76 cm
120x80xh76 cm
140x80xh76 cm
160x80xh76 cm
180x80xh76 cm

GU0000111
GU0000237
GU0000486
GU0000239
GU0000164
GU0000243

IDEA+
IDEA+

Tavoli con gambe a cavalletto distaccate dal piano. Disponibili in varie larghezze, con profondità monofronte o bifronte. Possono essere usati come tavoli di lettura o come tavoli per riunioni.

Tables with trestle legs detached from the tabletop. Available in various widths and depths. They can be used as reading tables or as meeting tables.



TAVOLO IDEA+ DOPPIO
IDEA+ double table

140x124xh76 cm
160x124xh76 cm

GC0005624
GC0005625

ACCESSORI
ACCESSORIES



TOP ACCESS
top access

3 prese UNEL
4 prese UNEL
3 prese UNEL e 2 prese USB
2 prese UNEL e 2 prese rete RJ45

GB0000263
GB0000274
GB0000308
GB0000260



TOP ACCESS DUAL
top access dual

3 prese UNEL
4 prese UNEL
3 prese UNEL e 2 prese USB
4 prese UNEL e 2 prese rete RJ45

GB0000272
GB0000278
GB0000269
GB0000273



LAMPADA A PONTE
table lamp

Lampada led 35W 3000°K

Led lamp 35W 3000°K

160 cm

GC0005235



**TAVOLO RIUNIONE QUADRATO,
BASE CUBO**
square meeting room table, cube base

140x140xh76,8 cm **GU0000643**

TAVOLI RIUNIONE
meeting room tables

**Tavoli con piano di superficie ampia.
Di varie forme e dimensioni,
con strutture diversamente
caratterizzate.**

Tables with large tops.
Available in various shapes and sizes.



TAVOLO POP-UP
POP-UP table

120x70xh75 cm
140x70xh75 cm
160x70xh75 cm
180x70xh75 cm

GU0002748
GU0002274
GU0002747
GU0000617



120x80xh75 cm
140x80xh75 cm
160x80xh75 cm
180x80xh75 cm

GU0002262
GU0002263
GU0002264
GU0002265

POP-UP
POP-UP

**Tavoli con struttura metallica
su ruote e piano in legno ribaltabile.
Per un uso flessibile, di semplice
spostamento e stoccaggio.
Possono essere dotati di ganci
per unire i piani frontalmente
e lateralmente.**

Tables with metal structure on castors
and folding wooden top, to ensure easy
movement and storage.
They can be equipped with hooks
to join the tabletops frontally and laterally.



TAVOLO RIUNIONE RETTANGOLARE
rectangular meeting room table

210x100xh76 cm **GU0000644**



TAVOLO RIUNIONE OVALE
oval meeting room table

200x110xh76 cm **GU0000068**



TAVOLO TONDO CON GAMBONE
round table with central leg

Ø100xh76 cm
Ø120xh76 cm

GU0000273
GU0000037



TAVOLO KAPIO QUADRATO
KAPIO square table

70x70xh75 cm

GC0003227

TAVOLI CON GAMBA CENTRALE
tables with central leg

**Tavoli tondi o quadrati, in legno
e metallo o interamente in metallo.
Aspetto informale e facilità d'uso
con sedie di ogni tipo.**

Round or square tables, in wood
and metal or entirely in metal.
Informal look and ease of use
with all kind of chairs.



TAVOLO ALTO
high table

120x80xh100 cm
140x80xh100 cm
160x80xh100 cm
180x80xh100 cm

GPN903900
GPN903901
GPN903902
GPN903903

TAVOLI ALTI
high tables

**Tavoli da utilizzare stando in piedi
o seduti su sgabelli.**

To be used while standing or sitting
on stools.



AMBIENTI PER
CONSULTAZIONE,
LETTURA, STUDIO

CONSULTATION,
READING, STUDY AREAS



86,5x60xh75 cm
96,5x60xh75 cm

GBORDA025
GBORDA026

86,5x60xh100 cm
96,5x60xh100 cm

GBORDA027
GBORDA028

CONSOLLE
console

**Tavolo per consultazione
o per postazione multimediale.**
Disponibile in due larghezze
e due altezze.

Table to be used for consultation
or as multimedia station.
Available in two widths and two heights.



60xh105 cm
60xh130 cm

GBORDA047
GBORDA048

PANNELLO DIVISORIO
divider panel

**Schermo per proteggere spazi
di lavoro individuali.**

Divider panel to delimit individual
workspaces.



POSTAZIONE OPAC CON ANTA
OPAC fixed workstation with CPU cabinet

70x63xh107,5 cm

GBOL00203



**POSTAZIONE OPAC FISSA
CON PIANO ANTICADUTA**
OPAC fixed workstation with anti-fall
protection

70x59xh107,5 cm
con | with box CPU
con | with consolle CPU

GBOL00101
GBOL00201
GBOL00301



**POSTAZIONE OPAC REGOLABILE
ELETTRICA CON PIANO ANTICADUTA**
OPAC height-adjustable workstation
with anti-fall protection

70x59xh67/110,5 cm

GBOL00105



**POSTAZIONE OPAC FISSA
CON PIANO SAGOMATO**
OPAC fixed workstation
with top integrated case

70x59xh107,5 cm
con | with box CPU
con | with consolle CPU

GBOL00401
GBOL00501
GBOL00601



**POSTAZIONE OPAC REGOLABILE
ELETTRICA CON PIANO SAGOMATO**
OPAC height-adjustable workstation
with top integrated case

70x59xh67/110,5 cm

GBOL00305

POSTAZIONI OPAC

OPAC WORKSTATIONS

**Le postazioni OPAC si differenziano per il disegno
del piano e per le caratteristiche della gamba,
ad altezza fissa o regolabile.**
**Le postazioni a gamba fissa possono essere dotate
di alloggiamento per PC, aperto in metallo o chiuso
in legno.**

The OPAC workstations differ in the design of the top
and in the characteristics of the leg, with fixed or adjustable height.
The fixed workstations can be equipped with a metal
or wooden CPU holder.

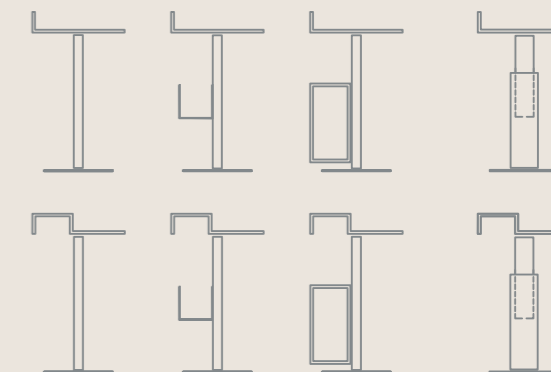

SEDUTE LETTURA E MULTIUSO MULTIPURPOSE AND READING CHAIRS



**SEDIA KALEA CON SEDUTA IMBOTTITA,
BICOLORE, BASE A 4 GAMBE**
KALEA chair with upholstered seat,
two-color, 4-leg base

52x53xh46/80 cm

GC0002554



**SEDIA KALEA CON SEDUTA
E SCHIENALE IMBOTTITI, BICOLORE,
BASE A 4 GAMBE**
KALEA chair with upholstered seat
and backrest, two-color, 4-leg base

52x53xh46/80 cm

GC0002711

KALEA KALEA

**Sedie e sgabelli, mono o bicolori,
con basi a 4 gambe, a slitta
e a 4 ruote.**
**Seduta e schienale possono essere
imbottiti.**
Tutti i modelli sono impilabili.

Chairs and stools available one-color
or two-color, with 4-leg, sled
or 4-caster base.
Seat and back can be upholstered.
All models are stackable.



**SEDIA KALEA BICOLORE,
BASE A 4 GAMBE**
KALEA chair, two-color, 4-leg base

52x53xh46/80 cm

GC0001808



**SEDIA KALEA BICOLORE, CON
TAVOLETTA SCRITTOIO ANTIPANICO,
BASE A 4 GAMBE**
KALEA chair with tilting tablet, two-color,
4-leg base

60x72xh46/73/80 cm

GC0002730



**SEDIA KALEA BICOLORE,
BASE A SLITTA**
KALEA chair, two-color, sled base

52x53xh46/80 cm

GC0002129



**SEDIA KALEA BICOLORE, GIREVOLE,
BASE A 4 RAZZE SU RUOTE**
KALEA swivel chair, two-color, 4-caster base

46x53xh46/81 cm

GC0005678



**SGABELLO KALEA BICOLORE,
BASE A 4 GAMBE CON POGGIPIEDI**
KALEA stool, two-color, 4-leg base
with footrest

52x53xh72/107 cm

GC0002335



CARRELLO PORTASEDIE KALEA
trolley for KALEA chairs

GC0000544

AMBIENTI PER
CONSULTAZIONE,
LETTURA, STUDIO

CONSULTATION,
READING, STUDY AREAS



SEDIA CLOP, BASE A 4 GAMBE
CLOP chair, 4-leg base

58x58xh44/84cm

GC0005687



SEDIA CLOP, BASE A SLITTA
CLOP chair, sled base

58x58xh44/84cm

GC0005688

CLOP
CLOP

**Poltroncina monoscocca
in polipropilene rinforzato.
Disponibile con sedile imbottito.**

Monocoque polypropylene chair.
Available with upholstered seat.



SEDIA KICCA, BASE A 4 GAMBE
KICCA chair, 4-leg base

54x55xh46/76 cm

GC0000654



SEDIA KICCA, BASE A SLITTA
KICCA chair, sled base

54x55xh46/76 cm

GC0000561

KICCA
KICCA

**Sedie e sgabelli monoscocca
in polipropilene.
Le sedie con base a 4 gambe
e a slitta sono impilabili.**

Polypropylene monocoque chairs
and stools.
The chairs with 4-leg and sled base
are stackable.



**SEDIA CLOP CON SEDUTA IMBOTTITA,
BASE A 5 RAZZE SU RUOTE**
CLOP chair with upholstered seat,
5-castor base

65x68xh40/53 cm

GC0005689



TAVOLETTA SCRITTOIO
tablet

GC0005690



SEDIA KICCA, BASE 4 RAZZE SU RUOTE
KICCA chair, 4-castor base

54x55xh46/76 cm

GC0005681



SEDIA KICCA, BASE 5 RAZZE SU RUOTE
KICCA chair, 5-castor base

54x55xh43/55 cm

GC0001975



**SGABELLO KICCA, BASE AD ALTEZZA
REGOLABILE**
KICCA stool, height-adjustable base

47x55xh56/81 cm

GC0005682



**SEDIA KLIA, CON E SENZA BRACCIOLI,
BASE A 4 GAMBE**
KLIA chair, 4-leg base

46x56xh46/80 cm
57x54xh46/80 cm braccioli | armrests

GC0005679
GC0005680



CARRELLO PORTASEDIE KLIA
trolley for KLIA chairs

GC0000544

KLIA
KLIA

**Sedia monoblocco in polipropilene
rinforzato con fibra di vetro.
Entrambe le versioni sono impilabili.**

Monobloc chair in polypropylene
reinforced with glass fibre.
Both versions are stackable.



ARREDI FONOASSORBENTI SOUND-ABSORBING FURNISHINGS

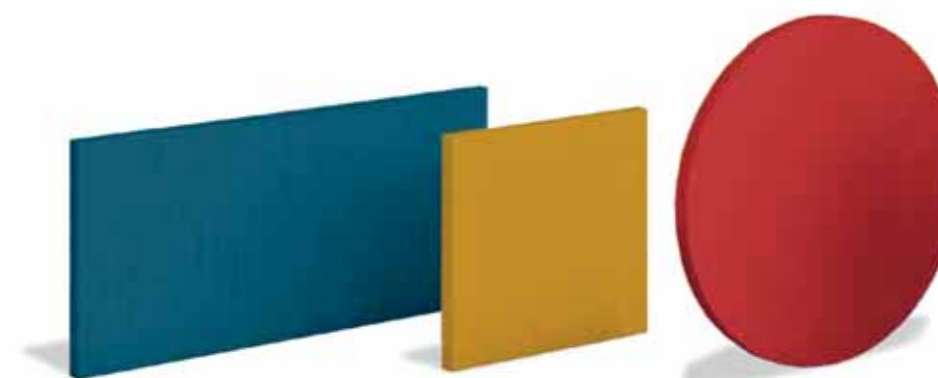

PANNELLI FONOASSORBENTI sound-absorbing panels

**Pannelli in molte forme e colori,
da montare a parete o a soffitto.
Riducono il riverbero e migliorano
il comfort acustico degli ambienti.**

Panels in many shapes and colors,
to be mounted on the wall or ceiling.
They reduce reverberation and improve
acoustic comfort in the rooms.



PANNELLO SOLUTION SOLUTION PANEL

**Pannelli PHONOLOOK
con spigoli ad angolo vivo,
rivestiti in tessuto ignifugo.**

PHONOLOOK panels
with sharp corners, covered
in fireproof fabric.



PANNELLO DESIGN DESIGN PANEL

**Pannelli PHONOLOOK
bifacciali con finitura
perimetrale, rivestiti
in tessuto ignifugo.**

PHONOLOOK double-sided
panels with perimeter finish,
covered in fireproof fabric.

SOLUTION
spessore 50 mm

DESIGN
spessore 50 mm



60x60 cm
120x120 cm

GP0903000
GP0903001

GP0903100
GP0903101



120x30 cm
180x30 cm
120x60 cm
180x60 cm
180x120 cm

GP0903002
GP0903003
GP0903004

GP0903104
GP0903105
GP0903106
GP0903107



Ø60 cm
Ø100 cm

GP0903011
GP0903012

GP0903114
GP0903115

KIT FISSAGGIO A PARETE/SOFFITTO PHONOLOOK

PHONOLOOK panel – wall/ceiling fixing kit **GP0903013**

KIT CAVI IN ACCIAIO PER SOSPENSIONE PANNELLI PHONOLOOK SOLUTION

PHONOLOOK SOLUTION panel – steel cable
suspension kit **GP0903014**

KIT CAVI IN ACCIAIO PER SOSPENSIONE PANNELLI PHONOLOOK DESIGN

PHONOLOOK DESIGN panel – steel cable
suspension kit **GP0903015**

AMBIENTI PER CONSULTAZIONE, LETTURA, STUDIO

CONSULTATION,
READING, STUDY AREAS



PANNELLI FONOASSORBENTI RETROSCAFFALE

rear shelf sound-absorbing panels

Pannelli fonoassorbenti da fissare con magneti alla struttura degli scaffali MODULAR. Disponibili in molti colori, individuano spazi di lettura e di consultazione con ottimo comfort acustico.

Sound-absorbing panels to be fixed with magnets to the structure of the MODULAR shelves. Available in many colors, they define reading and consultation spaces with excellent acoustic comfort.



TENDE FONOASSORBENTI

sound-absorbing curtains

Tende in tessuto fonoassorbente, da agganciare a binari lineari o curvilinei. Definiscono spazi raccolti e confortevoli, per lettura informale o incontri.

Curtains in sound-absorbing fabric, to be hooked to linear or curved tracks. They define cozy and comfortable spaces for informal reading or meetings.



PANNELLO FONOASSORBENTE RETROSCAFFALE

rear shelf sound-absorbing panel

87xh149,5 cm **GC0005718**
97xh149,5 cm **GC0005716**
87xh174,5 cm **GC0005719**
97xh174,5 cm **GC0005717**

PANNELLO FONOASSORBENTE RETROSCAFFALE ANGOLO

rear shelf sound-absorbing panel – corner

85xh149,5 cm **GC0005722**
95xh149,5 cm **GC0005720**
85xh174,5 cm **GC0005723**
95xh174,5 cm **GC0005721**

PANNELLO RETROSCAFFALE IN LAMIERA FORATA

rear shelf panel in perforated metal sheet

87xh149,5 cm **GB1P058SS**
97xh149,5 cm **GB1P056SS**
87xh174,5 cm **GB1P059SS**
97xh174,5 cm **GB1P057SS**

RIPIANO ANGOLARE PER SCAFFALI MONOFRONTI

corner shelf for single-sided shelves

90° p/d 25 cm **GB0R004SS**
90° p/d 30 cm **GB0R003SS**



COMPOSIZIONE LINEARE

linear configuration

220xh300 cm



COMPOSIZIONE RETTANGOLARE

rectangular configuration

300x220xh300 cm



COMPOSIZIONE TONDA

round configuration

Ø320xh300 cm

GC0005724

COMPOSIZIONI CONFIGURATIONS

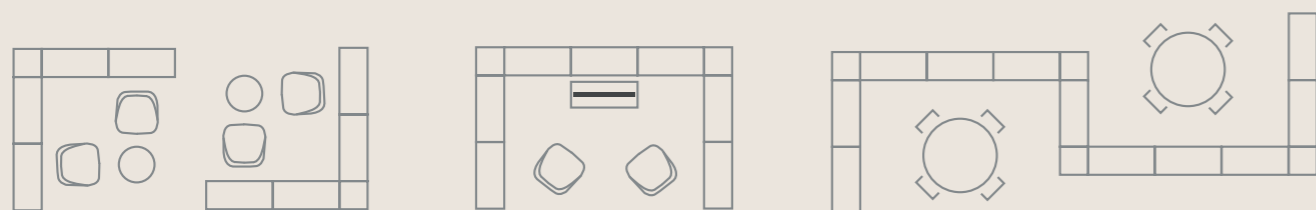

COMPOSIZIONI CONFIGURATIONS

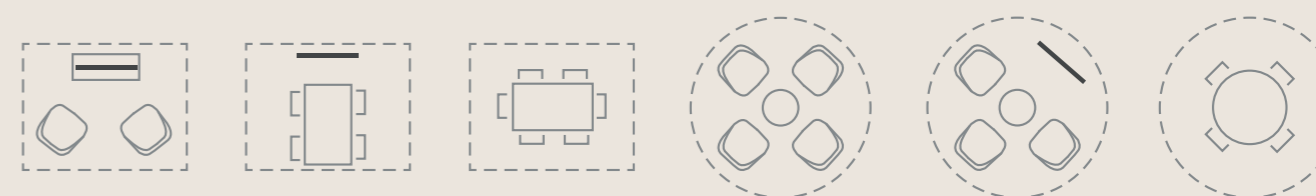



SPAZI PER RAGAZZI E BAMBINI CHILDREN AND TEENS ENVIRONMENTS

La biblioteca è amica dei più giovani. Accende il loro interesse e lo alimenta. Propone occasioni uniche, che non trovano neppure a scuola. Per i ragazzi è una grande finestra sul mondo e attraverso il tempo. Posto dove concentrarsi da soli e luogo d'incontro e socializzazione. Ai bambini si offre come spazio a loro misura, di racconto e di scoperta. Anche come laboratorio dove sperimentare. I più piccoli trovano ambiti accoglienti, protetti e sicuri. Cominciano a conoscere e ad amare i libri, prima di imparare a leggere.

The library is a friend to the youngest, it fuels their interest in reading and offers unique learning opportunities. For kids, it's a great window into the world and through time. A place to concentrate but also a place to meet and socialize. Children find a space tailored to them, a place for storytelling and discovery. The library is also a laboratory in which to experiment. The little ones find welcoming, protected, and safe environments. They begin to know and love books before learning to read.

SPAZI PER RAGAZZI E BAMBINI

CHILDREN AND TEENS
ENVIRONMENTS



SISTEMA 618 – CONTENITORI

SYSTEM 618 – cabinets

Contenitori non solo per libri.
Moduli di varie altezze e larghezze, aperti o chiusi ad ante, compongono un sistema ricco e flessibile. La gamma colori consente di realizzare molte combinazioni cromatiche.

Cabinets not only for books.
Modules of various heights and widths – open or with doors – make up a rich and flexible cabinet system.
The wide color range allows to create many different combinations.

ANGOLO

CORNER

Un modulo a giorno funziona come elemento angolare del sistema.
Consente di realizzare composizioni freestanding per suddividere e articolare grandi ambienti.

An open module works as the corner element of the system. It allows to build freestanding compositions to split large rooms into smaller spaces.

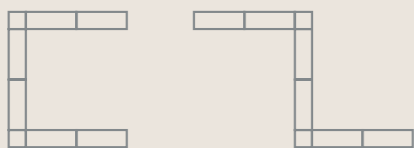

COLONNA 2 CASELLE

2-compartment column
H 91 cm



su piedi
on feet **GPN600800**

senza piedi
without feet **GPN600801**

su ruote
on castors **GPN600802**

COLONNA 3 CASELLE

3-compartment column
H 129 cm



su piedi
on feet **GPN601900**

senza piedi
without feet **GPN601901**

su ruote
on castors **GPN601902**

COLONNA 4 CASELLE

4-compartment column
H 168 cm



su piedi
on feet **GPN603200**

L/W 45 cm

CONTENITORE A CASELLE

open compartment cabinet
H 91 cm
H 79 cm **senza piedi** | without feet

CONTENITORE AD ANTE

door cabinet
H 91 cm
H 79 cm **senza piedi** | without feet

CONTENITORE A CASELLE

open compartment cabinet
H 129 cm
H 117 cm **senza piedi** | without feet

CONTENITORE AD ANTE

door cabinet
H 129 cm
H 117 cm **senza piedi** | without feet

CONTENITORE A CASELLE

open compartment cabinet
H 168 cm

CONTENITORE AD ANTE

door cabinet
H 168 cm

ELEMENTO BASE | BASE CABINET

ELEMENTO BASE

base cabinet
H 31 cm
H 19 cm **senza piedi** | without feet

ELEMENTO BASE

base cabinet
H 44 cm

L/W 80 cm



su piedi
on feet **GPN600300**

senza piedi
without feet **GPN600301**

su ruote
on castors **GPN600302**



su piedi
on feet **GPN600500**

senza piedi
without feet **GPN600501**

su ruote
on castors **GPN600502**



su piedi
on feet **GPN601300**

senza piedi
without feet **GPN601301**

su ruote
on castors **GPN601302**



su piedi
on feet **GPN601500**

senza piedi
without feet **GPN601501**

su ruote
on castors **GPN601502**



su piedi
on feet **GPN602300**



su piedi
on feet **GPN602500**

L/W 120 cm



su piedi
on feet **GPN610300**

senza piedi
without feet **GPN610301**

su ruote
on castors **GPN610302**



su piedi
on feet **GPN610500**

senza piedi
without feet **GPN610501**

su ruote
on castors **GPN610502**



su piedi
on feet **GPN611300**

senza piedi
without feet **GPN611301**

su ruote
on castors **GPN611302**



su piedi
on feet **GPN611500**

senza piedi
without feet **GPN611501**

su ruote
on castors **GPN611502**



ZOCCOLO plinth

45x45xh12 cm **GPN615020**

80x45xh12 cm **GPN615021**

120x45xh12 cm **GPN615022**

L/W 80 cm



su piedi
on feet **GPN620000**

senza piedi
without feet **GPN620001**

su ruote
on castors **GPN620002**



su piedi
on feet **GPN620100**

senza piedi
without feet **GPN620101**

su ruote
on castors **GPN620102**



su piedi
on feet **GPN620008**

su ruote
on castors **GPN620009**



su piedi
on feet **GPN620114**

su ruote
on castors **GPN620115**

SPAZI PER RAGAZZI E BAMBINI

CHILDREN AND TEENS
ENVIRONMENTS



















SISTEMA 618 – ACCESSORI

SYSTEM 618 – accessories

Casellari, espositori, fioriere, lavagne, appendiabiti, sedute, nicchie e microspazi.
Una serie di accessori amplia la funzionalità del sistema, per definire spazi ben caratterizzati.

Filing cabinets, displays, planters, blackboards, hangers, seats, niches and micro-spaces.

The accessories expand the functionality of the system to set up well-characterized spaces.

 TOP A CASELLE cubby top 80x45xh38 cm 120x45xh38 cm GPN620400 GPN620500	 TOP A CASELLE cubby top 80x45xh38 cm 120x45xh38 cm GPN620401 GPN620501	 TOP ESPOSITORE display top 80x45xh38 cm 120x45xh38 cm GPN620402 GPN620502	 TOP ESPOSITORE ORIZZONTALE horizontal display top 180x45xh19 cm 120x45xh19 cm GPN620403 GPN620503
 TOP FIORIERA flower box top 80x45xh77 cm 120x45xh77 cm GPN620405 GPN620505	 TOP LAVAGNA writing board top 80x45xh77 cm 120x45xh77 cm GPN620406 GPN620506	 MENSOLA shelf 80x45xh15 cm 120x45xh15 cm GPN620408 GPN620508	 PUNTO E VIRGOLA PUNTO e VIRGOLA PUNTO PUNTO E VIRGOLA GPN620601 GPN620601
 CUSCINO cushion 80x45xh7 cm 120x45xh7 cm GAI239002 GAI239001	 CUBO MORBIDO cube soft seating 36x36xh36 cm GPN620700	 VANO MULTIUSO CON SCHIENALE FORATO multipurpose compartment – back with holes 80x45xh98 cm 80x45xh137 cm 120x45xh98 cm 120x45xh137 cm GPN620006 GPN620007 GPN620106 GPN620107	 PUNTO E VIRGOLA PUNTO e VIRGOLA PUNTO PUNTO E VIRGOLA GPN620601 GPN620601
 COCOON cocoon reading pod 120x45xh137 cm GPN620104	 NICCHIA CON CUSCINI reading pod with cushions 160x60xh168 cm materasso compreso mat included GPN620110 GAI000215	 NICCHIA CON TAVOLINO reading pod with table 190x60xh168 cm materasso compreso mat included GPN620112 GAI000216	 MICROSPAZIO microspace 190x190xh190 cm materasso compreso mat included GPN620122 GAI000217

DIMENSIONI

SIZES

Accessori e pezzi speciali si inseriscono nella griglia dimensionale del sistema.

Size chart for accessories and special items.



SPAZI PER RAGAZZI E BAMBINI

CHILDREN AND TEENS ENVIRONMENTS



SISTEMA 618 – MODULI CURVI

SYSTEM 618 – curved cabinets

Contenitori curvilinei compongono nicchie, isole, linee sinuose. Definiscono spazi concavi e convessi. Contenitori e sedute coordinate formano piccoli ambienti riparati, per lettura, incontri, relax.

Curvilinear cabinets make up niches, islands, sinuous lines. They define concave and convex spaces. Coordinated cabinets and seats form cozy areas for reading, meeting, relaxing.



DIMENSIONI

SIZES

I contenitori curvilinei sono disponibili in due altezze coordinate con i contenitori lineari.

Curved cabinets are available in two heights, coordinated with the straight modules.

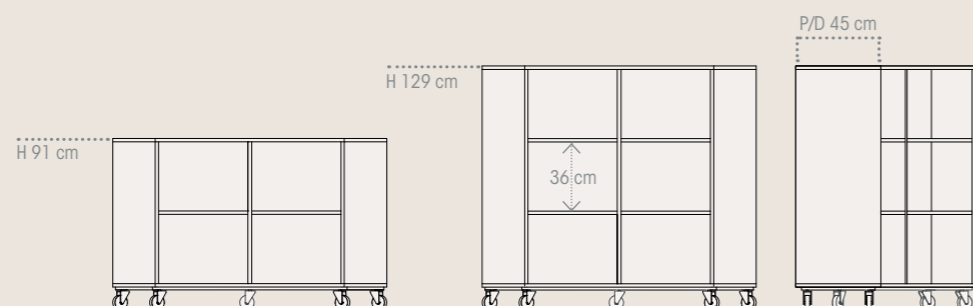

CONTENITORE A CASELLE CURVO

curved cabinet

H 91 cm
H 79 cm senza piedi | without feet

	R 100-145 cm			
su piedi on feet	 GPN614000	 GPN614100	 GPN614200	 GPN614300
senza piedi without feet	GPN614001	GPN614101	GPN614201	GPN614301
su ruote on castors	GPN614002	GPN614102	GPN614202	GPN614302

CONTENITORE A CASELLE CURVO

curved cabinet

H 129 cm
H 117 cm senza piedi | without feet

su piedi on feet	 GPN614400	 GPN614500	 GPN614600	 GPN614700
senza piedi without feet	GPN614401	GPN614501	GPN614601	GPN614701
su ruote on castors	GPN614402	GPN614502	GPN614602	GPN614702

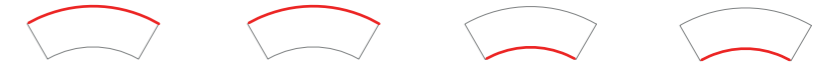

TELAIO SU PIEDI
frame on feet

GPN615003











TELAIO SU RUOTE
frame on castors

GPN615004

La base dei contenitori è un telaio metallico su piedi o su ruote.

The base of the cabinets is a metal frame with feet or castors.

SEDUTE CURVILINEE | CURVED SEATS

			
			
R55-100x45xh38 cm GPN616104 R65-100x35xh38 cm GPN616100	R100-145x45xh38 cm GPN616101	R145-190x45xh38 cm GPN616102	Ø90xh38 cm GPN616103

TAVOLI E SEDUTE
TABLES AND CHAIRS



SISTEMA 618 – TAVOLI
SYSTEM 618 – tables

Tavoli diversi, per forma, dimensione, struttura e accessori, rispondono a molteplici esigenze. Per tanti usi, per grandi e piccoli, in ogni ambiente della biblioteca.

Different tables in terms of shape, size, structure and accessories, respond to multiple needs. Suitable for adults and children, they fit multiple uses in any library setting.



TAVOLO STUDIO 1
study table 1

165x60xh75 cm
165x60xh100 cm

GPN600200
GPN600201



TAVOLO STUDIO 2
study table 2

165x60xh75 cm
165x60xh100 cm

GPN600205
GPN600206



TAVOLO STUDIO 3
study table 3

165x60xh75 cm
165x60xh100 cm

GPN600210
GPN600211



CONTENITORE SOPRAPIANO
countertop unit

60x45xh38 cm

GPN600220



TAVOLO REGOLABILE SU CAVALLETTI
height-adjustable table on trestles

220x80xh75-90 cm

GC0003502

SPAZI PER RAGAZZI E BAMBINI

CHILDREN AND TEENS
ENVIRONMENTS

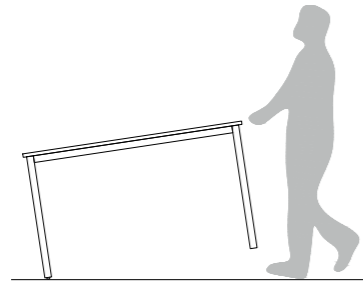

TAVOLI SU RUOTE

tables on castors

Ruote inserite al piede di due gambe facilitano lo spostamento.

Invisible castors inserted at the ends of two legs facilitate movement.

TAVOLI IMPILABILI

stackable tables

Tavoli quadrati, rettangolari e tondi sono disponibili anche in versione impilabile con due o quattro gambe esterne al piano.

Square, rectangular, and round tables are available also in stackable version with two or four legs external to the tabletop.

SISTEMA 06 – TAVOLI

SYSTEM 06 – tables

Per i bambini sono disponibili tavoli in legno con gambe cilindriche e bordi arrotondati. Anche uno speciale tavolo basso, da usare stando seduti per terra.

Wooden tables with cylindrical legs and rounded edges are available for children. There is also a special low table, to be used while sitting on the floor.



TAVOLO QUADRATO
square table

	FISSO FIXED	SU RUOTE ON CASTORS	IMPILABILE STACKABLE	IMPILABILE SU RUOTE STACKABLE ON CASTORS
65x65xh58 cm	GPN900103	GPN900133	GPN900123	GPN900163
65x65xh64 cm	GPN900104	GPN900134	GPN900124	GPN900164
65x65xh70 cm	GPN900105	GPN900135	GPN900125	GPN900165
65x65xh76 cm	GPN900106	GPN900136	GPN900126	GPN900166
80x80xh58 cm	GPN900203	GPN900233	GPN900223	GPN900263
80x80xh64 cm	GPN900204	GPN900234	GPN900224	GPN900264
80x80xh70 cm	GPN900205	GPN900235	GPN900225	GPN900265
80x80xh76 cm	GPN900206	GPN900236	GPN900226	GPN900266
130x130xh58 cm	GPN900303	GPN900333	GPN900323	GPN900363
130x130xh64 cm	GPN900304	GPN900334	GPN900324	GPN900364
130x130xh70 cm	GPN900305	GPN900335	GPN900325	GPN900365
130x130xh76 cm	GPN900306	GPN900336	GPN900326	GPN900366
140x80xh58 cm	GPN901103	GPN901133	GPN901123	GPN901163
140x80xh64 cm	GPN901104	GPN901134	GPN901124	GPN901164
140x80xh70 cm	GPN901105	GPN901135	GPN901125	GPN901165
140x80xh76 cm	GPN901106	GPN901136	GPN901126	GPN901166
160x80xh58 cm	GPN901203	GPN901233	GPN901223	GPN901263
160x80xh64 cm	GPN901204	GPN901234	GPN901224	GPN901264
160x80xh70 cm	GPN901205	GPN901235	GPN901225	GPN901265
160x80xh76 cm	GPN901206	GPN901236	GPN901226	GPN901266
Ø100xh58 cm	GPN901603	GPN901633	GPN901623	GPN901663
Ø100xh64 cm	GPN901604	GPN901634	GPN901624	GPN901664
Ø100xh70 cm	GPN901605	GPN901635	GPN901625	GPN901665
Ø100xh76 cm	GPN901606	GPN901636	GPN901626	GPN901666
Ø130xh58 cm	GPN901803	GPN901833	GPN901823	GPN901863
Ø130xh64 cm	GPN901804	GPN901834	GPN901824	GPN901864
Ø130xh70 cm	GPN901805	GPN901835	GPN901825	GPN901865
Ø130xh76 cm	GPN901806	GPN901836	GPN901826	GPN901866



TAVOLO RETTANGOLARE
rectangular table



TAVOLO ROTONDO
round table



TAVOLO QUADRATO IN LEGNO
square wooden table

75x75xh40 cm	GA0240100
75x75xh46 cm	GA0240201
75x75xh53 cm	GA0240202
75x75xh59 cm	GA0240203
75x75xh76 cm	GA0240206



TAVOLO RETTANGOLARE IN LEGNO
rectangular wooden table

150x75xh40 cm	GA0241200
150x75xh46 cm	GA0241201
150x75xh53 cm	GA0241202
150x75xh59 cm	GA0241203
150x75xh76 cm	GA0241206



TAVOLO ROTONDO IN LEGNO
round wooden table

Ø90xh40 cm	GA0242800	Ø128xh40 cm	GA0243000
Ø90xh46 cm	GA0242801	Ø128xh46 cm	GA0243001
Ø90xh53 cm	GA0242802	Ø128xh53 cm	GA0243002
Ø90xh59 cm	GA0242803	Ø128xh59 cm	GA0243003
Ø90xh76 cm	GA0242806	Ø128xh76 cm	GA0243006



TAVOLO GIAPPONESE
japanese table

100x100xh30 cm	GV0003126
----------------	-----------



CUSCINO
cushion

30x30xh7 cm	GAI000153
-------------	-----------

SPAZI PER RAGAZZI E BAMBINI

CHILDREN AND TEENS
ENVIRONMENTS



SEDIA G-TYPE SU 4 GAMBE
G-TYPE chair on 4 legs

h34 cm **GPN907303**
h34 cm faggio | beech **GPN907403**
h38 cm **GPN907304**
h38 cm faggio | beech **GPN907404**
h42 cm **GPN907305**
h42 cm faggio | beech **GPN907405**
h46 cm **GPN907306**
h46 cm faggio | beech **GPN907406**



SEDIA G-TYPE SU RUOTE
G-TYPE chair on castors

h38/46 cm **GPN907600**
h38/46 cm faggio | beech **GPN907700**
h42/50 cm **GPN907602**
h42/50 cm faggio | beech **GPN907702**



SGABELLO G-TYPE
G-TYPE stool

h70 cm **GPN907800**



SEDIA POSTURA
POSTURA chair

h34 cm **GA0247113**
h38 cm **GA0247114**
h42 cm **GA0247115**
h46 cm **GA0247116**



SEGGIOLINA IN LEGNO IMPILABILE
stackable wooden chair

30x25,5xh26/54 cm **GA0246901**
32x28xh31/60 cm **GA0246902**
32x32xh35/67 cm **GA0246903**
34,5x34xh38/71 cm **GA0246904**
38x40xh46/83 cm **GA0246906**

SEDIE chairs

**Sedie in plastica e in legno,
impilabili, a misura dei bambini.**

Plastic and wooden chairs, stackable,
suitable for children.

G-TYPE

G-TYPE

G-TYPE è la nuova sedia ideata da GAM e prodotta in collaborazione con la capogruppo iMilani. È un progetto originale, sviluppato con il contributo di competenze specialistiche, per trovare la miglior sintesi di estetica, funzionalità, qualità produttiva. G-TYPE è disponibile in cinque colori e in legno compensato curvato, su quattro gambe, su slitta cantilever o a cinque razze su ruote. I modelli su gambe e slitta sono impilabili. Con finitura antracite è disponibile nella versione in plastica riciclata o ignifuga in CL1. Il design è di Giovanni Fumagalli e Claudio Gorgi.

G-Type is the new chair designed by GAM and produced in collaboration with the parent company iMilani. This peculiar project, developed through specialized skills, aims to find the best synthesis of aesthetics, functionality, production quality. G-Type chair is available in five colors and in curved natural plywood. The base can be on four legs, cantilever or with five castors. The legs and cantilever models are stackable. The anthracite shell is also available in CL1 fireproof recycled plastic. The design is by Giovanni Fumagalli and Claudio Gorgi.



SEGGIOLINA PLURIPÌÙ
PLURIPÌÙ chair

36x31,4xh31,4 cm **GA0245800**
seduta | seat h16/21 cm **GA0245801**
riduttore | reducer



PLURIPÌÙ è una seggiola pluriuso per bambini da 0 a 3 anni. Tre posizioni e tre altezze di seduta. I fori e i bottoni sui fianchi consentono anche di realizzare scaffali e divisori.

PLURIPÌÙ is a multipurpose chair for children aged 0 to 3 years. Three positions and three seat heights. The holes and buttons on the sides also allow to make shelves and dividers.



SGABELLO TURIN
TURIN stool

h42/55 cm **GC0003873**
h60/72 cm **GU0002769**



SGABELLO FISSO IN LEGNO
fixed wooden stool

27x27xh25 cm **GA0247311**
27x27xh30 cm **GA0247312**
36x36xh45 cm **GA0247315**

SGABELLI stools

Sgabelli ad altezza regolabile con struttura metallica, per spazi laboratoriali, e in legno impilabili, per ogni ambiente.

Height-adjustable stools with metal structure for laboratories, and stackable wooden ones for any environment.

PEZZI SPECIALI
SPECIAL ITEMS



CASAMIA BIBLIO
CASAMIA BIBLIO

CASAMIA BIBLIO è una biblioteca minima. Pannello libreria, panca contenitore, pouf, cuscini e tappeto, fanno del classico microspazio GAM un piccolo luogo speciale, dedicato al primo incontro dei bambini con i libri.

CASAMIA BIBLIO is a mini-library. Library-panel, display bench, pouf, cushions, and carpet turn GAM micro-space into a cozy place dedicated to the children's first encounters with books.



SPAZI PER RAGAZZI E BAMBINI

CHILDREN AND TEENS
ENVIRONMENTS



CASAMIA CASAMIA

185x115x185 cm
185x228x185 cm
185x340x185 cm

GA0264000
GA0264001
GA0264002



TELO BIANCO white canvas sheet

208x107 cm

GA0264010



SEDUTA CONTENITORE container bench

105x27,5x22 cm

GA0264012



PANNELLO PORTALIBRI book display pannel

105x55 cm

GA0264013



GREEN CASAMIA GREEN CASAMIA

Portavasi e griglie vestono CASAMIA come un microspazio verde. Piccolo laboratorio di coltivazione, serra senza vetri, rifugio per bambini che vogliono appartarsi con le piante.

Potholders and grids transform CASAMIA into a green micro-space. Small cultivation laboratory, glassless greenhouse, shelter for children who want to discover plants.



SEDUTA MORBIDA LINEARE linear padded bench

105x27,5x22 cm

GAI000156



POUF pouf

Ø30x22 cm

GAI000155



CUSCINO cushion

Ø30x4 cm

GAI000157



SEDUTA MORBIDA A ELLE L-shaped padded bench

105x30/70x8 cm

GAI000154



SCHIENALE padded backrest

105x55 cm

GAI000158



TAPPETO carpet

185x110 cm

GA0286243

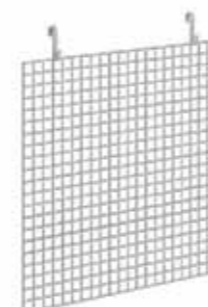

GRIGLIA PORTAVASI potholder grid

105x105 cm

GA0266064



PANNELLO PORTAVASI potholder panel

105x55 cm

GA0266063



ALBERO DEI VASI pot tree

Ø100xh123 cm
Ø100xh143 cm

GA0241525
GA0241526

PEDANE, POUF, MORBIDI
STAGES, POUFS, SOFT FURNISHINGS



PEDANE E QUADRI
stages and squares

Pedane ed elementi quadrati e rettangolari, in tre altezze, realizzano composizioni a gradoni. Quadri espositori e a pannello completano sulle pareti l'allestimento di spazi informali versatili.

Stages and square and rectangular elements in three heights create stepped compositions. Wall displays and panels complete the setting up of versatile informal spaces.



PEDANA QUADRATA
square stage

80x80xh19 cm **GP0909210**
80x80xh38 cm **GP0909211**
80x80xh57 cm **GP0909212**
160x160xh19 cm **GP0909215**



PEDANA RETTANGOLARE
rectangular stage

160x80xh19 cm **GP0909220**



CONTENITORE
storage box

80x80xh19 cm **GP0909225**
80x80xh38 cm **GP0909226**



PEDANA PORTAVASI
potholder stage

80x80xh19 cm **GP0909235**
80x40xh57 cm **GP0909229**



CUSCINO PEDANA
cushion

40x40xh3 cm **GP0909230**
40x80xh3 cm **GP0909231**
80x80xh3 cm **GP0909232**



PANNELLO A PARETE
wall panel

80x80 cm **GP0909428**
160x80 cm **GP0909429**



PANNELLO PORTALIBRI A PARETE
wall book display

80x80xh8 cm **GP0909436**



CONTENITORE A PARETE
wall display

80x80xh19 cm **GP0909430**

SPAZI PER RAGAZZI E BAMBINI

CHILDREN AND TEENS
ENVIRONMENTS



ESAGONI hexagons

Forte impronta geometrica per composizioni aperte. Sistema di pedane, sedute e pannelli per realizzare ambiti informali.

Strong geometric imprint for open compositions. Stages, seats and panels to create informal settings.



GRADONI E PANCHE two-tiered seatings and benches

Gradoni e panche componibili arredano spazi per incontri, presentazioni, dibattiti.

Two-tiered seatings and modular benches furnish spaces for meetings, presentations, debates.



PANNELLO A PARETE
wall panel

96x83,1 cm **GP0909400**



PANNELLO TRAPEZOIDALE A PARETE
trapezoidal wall panel

96x41,6 cm **GP0909401**



ESPOSITORE A PARETE
wall display

96x83,1xh24 cm **GP0909402**
96x83,1xh32 cm **GP0909403**



ESPOSITORE TRAPEZOIDALE A PARETE
trapezoidal wall display

96x41,6xh24 cm **GP0909404**
96x41,6xh32 cm **GP0909405**



ESPOSITORE ORIZZONTALE
horizontal display

96x83,1xh24 cm **GP0909406**
96x83,1xh32 cm **GP0909407**



ESPOSITORE ORIZZONTALE ALTO
high horizontal display

96x83,1xh48 cm **GP0909408**
96x83,1xh56 cm **GP0909409**
96x83,1xh64 cm **GP0909410**



PEDANA TRAPEZIODALE
trapezoidal stage

96x41,6xh16 cm **GP0909411**
96x41,6xh24 cm **GP0909412**
96x41,6xh32 cm **GP0909413**
96x41,6xh48 cm **GP0909414**



PEDANA
stage

96x83,1xh16 cm **GP0909415**
96x83,1xh24 cm **GP0909416**
96x83,1xh32 cm **GP0909417**
96x83,1xh48 cm **GP0909418**



GRADONE
two-tiered seating

105x70xh76 cm **GPN909201**
105x105xh76 cm **GPN909200**



GRADONE ANGOLO
corner two-tiered seating

105x105xh76 cm **GPN909203**



PANCA
bench

80x45xh38 cm **GP0909102**
120x45xh38 cm **GP0909101**
180x45xh38 cm **GP0909100**



PANCA CON VANO
bench with open compartment

120x45xh38 cm **GP0909111**
180x45xh38 cm **GP0909110**



SEDUTA MORBIDA TRAPEZOIDALE
trapezoidal soft seating

96x41,6xh32 cm **GP0909419**
96x41,6xh48 cm **GP0909420**



SEDUTA MORBIDA
soft seating

96x83,1xh32 cm **GP0909423**
96x83,1xh48 cm **GP0909424**



CUSCINO
cushion

96x83,1xh8 cm **GP0909422**



TAPPETO
carpet

96x83,1 cm **GP0909421**



ANGOLO
corner element

45x45xh38 cm cablato con torretta with powerdock **GP0909003**
GP0909103



PANCHETTO
small bench

40x40xh35 cm **GP0909120**



CASSETTO SU RUOTE
drawer unit on castors

40x40xh33 cm **GP0909121**



CUSCINO
cushion

34x34xh3 cm **GP0909230**



SISTEMA 06 – POUF
SYSTEM 06 – poufs

Pouf di varie geometrie e dimensioni, tutti componibili, con gambe cilindriche in legno. SPECIAL O e SPECIAL X sono sedute particolari, aggregabili a incastro.

Modular poufs of various shapes and sizes, with cylindrical wooden legs. SPECIAL O and SPECIAL X are seats that can be joined together.



SMARTIPOUF
SMARTIPOUF

Ø50xh24 cm
Ø80xh42 cm

GAI223001
GAI223000



SMARTIPOUF FLAT
SMARTIPOUF flat

Ø50xh24 cm
Ø80xh42 cm

GAI223003
GAI223002



POUF TRIANGOLARE
triangular pouf

50x45xh35 cm

GAI223004



POUF TONDO
round pouf

Ø50xh35 cm

GAI223005



POUF QUADRATO
square pouf

50x50xh35 cm
75x75xh35 cm

GAI223006
GAI223008



POUF RETTANGOLARE
rectangular pouf

100x50xh35 cm

GAI223007



POUF QUADRATO
square pouf

45x45xh38 cm
80x80xh38 cm
45x45xh44 cm
80x480xh44 cm

GPN616200
GPN616201
GPN616202
GPN616203



POUF RETTANGOLARE
rectangular pouf

80x45xh38 cm
120x45xh38 cm
80x45xh44 cm
120x45xh44 cm

GPN616204
GPN616205
GPN616206
GPN616207



POUF CURVO
curved pouf

R100x45xh38 cm
R100x45xh44 cm

GPN616208
GPN616211



POUF TONDO
round pouf

Ø80xh38 cm
Ø80xh44 cm

GPN616209
GPN616212



POUF LUNA
half-moon pouf

Ø80xh38 cm
Ø80xh44 cm

GPN616210
GPN616213



POUF SPECIAL O
POUF SPECIAL O

Ø120xh35 cm

GAI223009



POUF SPECIAL X
POUF SPECIAL X

135x135xh35 cm

GAI223010

SISTEMA 618 – POUF
SYSTEM 618 – poufs

Pouf con struttura metallica coordinati ai contenitori del SISTEMA 618. Moduli curvi e LUNA compongono linee sinuose.

Pouf with metal structure coordinated with the cabinets of SYSTEM 618. Curved modules and LUNA make sinuous compositions.



POUF QUADRATO
square pouf

45x45xh38 cm
80x80xh38 cm
45x45xh44 cm
80x480xh44 cm

GPN616200
GPN616201
GPN616202
GPN616203



POUF RETTANGOLARE
rectangular pouf

80x45xh38 cm
120x45xh38 cm
80x45xh44 cm
120x45xh44 cm

GPN616204
GPN616205
GPN616206
GPN616207



POUF CURVO
curved pouf

R100x45xh38 cm
R100x45xh44 cm

GPN616208
GPN616211



POUF TONDO
round pouf

Ø80xh38 cm
Ø80xh44 cm

GPN616209
GPN616212



POUF LUNA
half-moon pouf

Ø80xh38 cm
Ø80xh44 cm

GPN616210
GPN616213

COMPOSIZIONI
CONFIGURATIONS

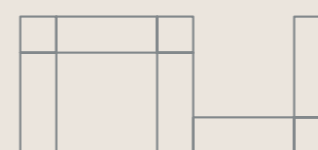

SPAZI PER RAGAZZI E BAMBINI

CHILDREN AND TEENS
ENVIRONMENTS



POUF poufs

Pouf di geometrie più complesse arricchiscono l'offerta di sedute informali per bambini e ragazzi.

Poufs with complex geometries enrich the offer of informal seating for children and teenagers.



MORBIDI soft furnishings

Per piccoli e piccolissimi, arredi morbidi per arredare spazi confortevoli e sicuri.

Soft furnishings for babies and toddlers, to furnish comfortable and safe spaces.



DELTA
DELTA

85x43,5xh42 cm

GAI292178



BETA
BETA

150x80xh42 cm

GAI292179



TETA
TETA

170x52xh42 cm

GAI292180



ZETA
ZETA

85x43,5xh42 cm

GAI292181



CUSCINO MONOCOLORE
one-color cushion

40x40 cm
60x60 cm

GAI206000
GAI206100

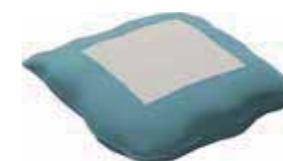

CUSCINO BICOLORE
two-color cushion

120x120 cm
Ø90 cm
Ø120 cm

GAI206200
GAI206600
GAI206700



ABBRACCIO MORBIDO
cosy cuddle

50x50xh20 cm

GAI209600



ABBRACCIO APOGGIO
cosy support

50x50x15/20xh18 cm

GAI209500



ALFA
ALFA

50x43,5xh42 cm

GAI292182



OMEGA
OMEGA

50x50xh42 cm

GAI292184



KAPPA
KAPPA

97x55xh42 cm

GAI292185



SIGMA
SIGMA

165x150xh42 cm
Ø50xh42 cm

GAI292187
GAI292186



PIANO QUADRATO
square surface

60x60xh13 cm
60x60xh26 cm
60x60xh39 cm

GAI217000
GAI217100
GAI217200



POUF QUADRATO
square pouf

50x50xh24 cm
50x50xh30 cm
60x60xh42 cm

GAI215300
GAI215301
GAI215302



POUF ROTONDO
round pouf

Ø40xh24 cm
Ø40xh30 cm
Ø40xh42 cm

GAI213000
GAI213100
GAI213200



Ø60xh32 cm
Ø60xh42 cm

GAI227300
GAI213203



TAPPETO IN TREFORD tredford carpet

150x150 cm
150x200 cm
200x200cm
200x300 cm
Ø150 cm
Ø200 cm
170x50 cm

GA0286400
GA0286401
GA0286402
GA0286403
GA0286404
GA0286405
GA0286406



TAPPETO IN MOQUETTE moquette carpet

150x150 cm
150x200 cm
200x200cm
200x300 cm
Ø150 cm
Ø200 cm

GA0286200
GA0286201
GA0286202
GA0286203
GA0286204
GA0286205



SET ARCOBALENO
rainbow set

Ø60 cm

GAI203700

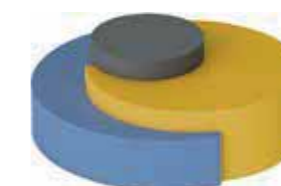

ECLISSE S
ECLISSE S

Ø120xh40 cm

GAI223301



SACCOTTO
beanbag

55x55xh85 cm
95x80xh90 cm

GAI225200
GAI225201

SISTEMA PARETE WALL SYSTEM



Pannelli modulari in vari materiali, con una serie di accessori, arredano le pareti. Lavagne, mensole, piani di lavoro, contenitori ed espositori, fissati su superfici verticali, moltiplicano gli spazi della biblioteca.

Modular panels in various materials furnish the walls. Blackboards, shelves, worktops, cabinets and displays multiply the library spaces.

DIMENSIONI

SIZES

Le dimensioni degli elementi del sistema sono coordinate con quelle dei contenitori. L'altezza complessiva è uguale a quella del contenitore H 168 con sovrapposto un TOP A CASELLE.

The sizes of the wall items are coordinated with those of the cabinets. The overall height is cm 206 (like a cabinet cm 168h with a CUBBY TOP).

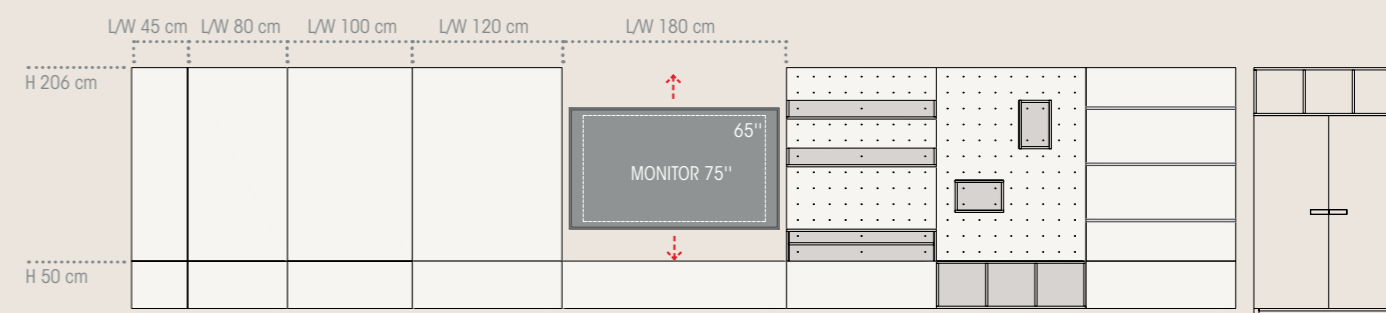

SPAZI PER RAGAZZI E BAMBINI

CHILDREN AND TEENS
ENVIRONMENTS



PANNELLO IN LEGNO
wooden wall panel

45x156 cm
80x156 cm
100x156 cm
120x156 cm

GP0941000
GP0941001
GP0941004
GP0941002



PANNELLO IN LEGNO FORATO
wooden wall panel with holes

45x156 cm
80x156 cm
100x156 cm
120x156 cm

GP0942200
GP0942201
GP0942204
GP0942202



PANNELLO IN SUGHERO
cork wall panel

45x156 cm
80x156 cm
120x156 cm

GP0941400
GP0941401
GP0941402



MENSOLA
shelf

45x25x15 cm
80x25x15 cm
120x25x15 cm

GP0944000
GP0944001
GP0944002



SCRITTOIO
writing top

45x43x25 cm
80x43x25 cm
120x43x25 cm

GP0944003
GP0944004
GP0944006



CONTENITORE A CASELLE
compartment top

45x45x38 cm
80x45x38 cm
120x45x38 cm

GP0944020
GP0944021
GP0944022



PANNELLO IN LAMINATO BIANCO
white HPL wall panel

45x156 cm
80x156 cm
120x156 cm

GP0941200
GP0941201
GP0941202



PANNELLO IN LAMINATO LAVAGNA
black HPL writing board wall panel

45x156 cm
80x156 cm
120x156 cm

GP0941600
GP0941601
GP0941602



PANNELLO FONOASSORBENTE
sound-absorbing wall panel

45x156 cm
80x156 cm
120x156 cm

GP0942000
GP0942001
GP0942002



**SCATOLA PER PANNELLO
IN LEGNO FORATO**
box for wooden noticeboard with holes

39x26x26 cm

GP0944023



SCATOLA
BOX

Semplice contenitore rettangolare aperto.
Da utilizzare in orizzontale o in verticale.

Rectangular open box.
To be used horizontally or vertically.



**PANNELLO IN LEGNO
CON GUIDE PER TASCHE***
wooden wall panel with slots*

45x156 cm
80x156 cm
120x156 cm

GP0942400
GP0942401
GP0942402



PANNELLO IN LEGNO BASSO
wooden wall panel – low

45x38 cm
80x38 cm
100x38 cm
120x38 cm

GP0943000
GP0943001
GP0943004
GP0943002



**PANNELLO IN LAMINATO BIANCO
BASSO**
white HPL wall panel – low

45x38 cm
80x38 cm
120x38 cm

GP0943200
GP0943201
GP0943202

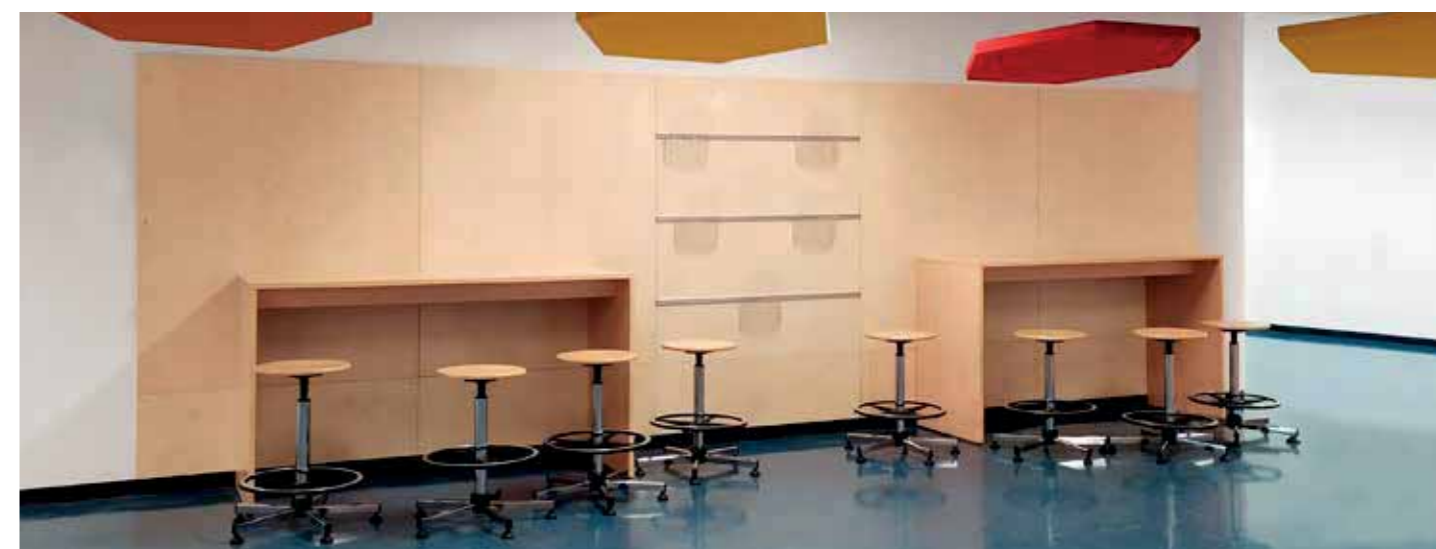

*TASCA non incluse
pocket not included

GC0001426

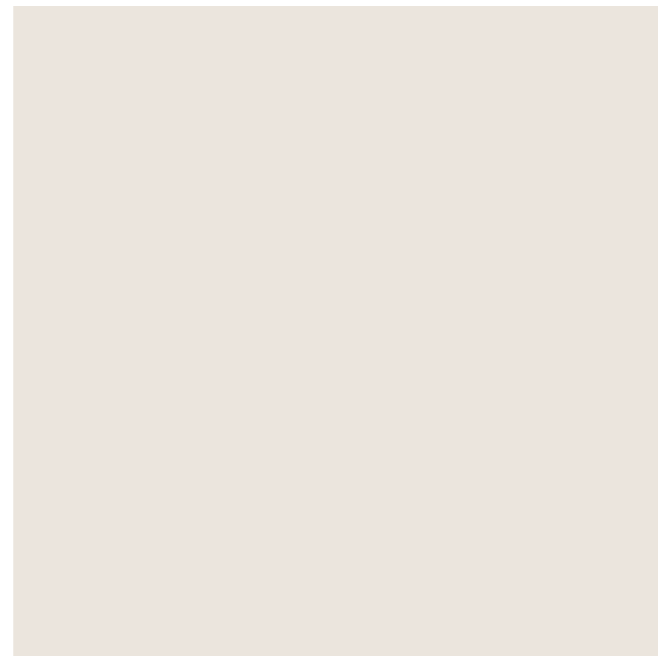



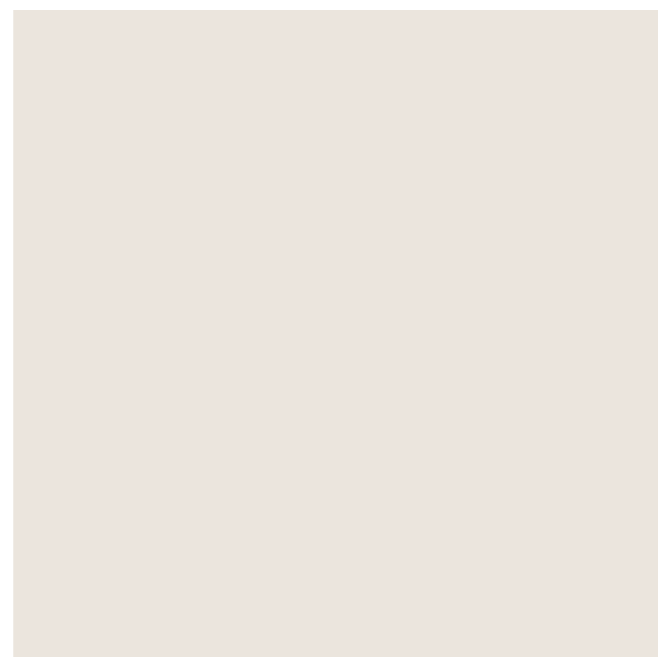

**ABACHI SCAFFALI,
CARTELLE COLORI**
SHELVES CODIFICATION, COLOR CHARTS



ABACO SISTEMA EPIFANO EPIFANO SHELVING SYSTEM – ITEM CODES





EPIFANO MONOFRONTE BASE | EPIFANO SINGLE-SIDED STARTER BAY

		L/W 74 cm	L/W 92 cm
EPIFANO BASE 3 RIPIANI + TOP EPIFANO starter bay 3 shelves + top H 90 cm		p/d 34 cm GB5M10276	GB5M10013
EPIFANO BASE 3 RIPIANI + TOP EPIFANO starter bay 3 shelves + top H 120 cm		p/d 34 cm GB5MBAI21	GB5MCAI21
EPIFANO BASE 4 RIPIANI + TOP EPIFANO starter bay 4 shelves + top H 150 cm		p/d 34 cm GB5M10257	GB5M10012
EPIFANO BASE 4 RIPIANI + TOP EPIFANO starter bay 4 shelves + top H 180 cm		p/d 34 cm GB5MBAG21	GB5MCAG21
EPIFANO BASE 5 RIPIANI + TOP EPIFANO starter bay 5 shelves + top H 210 cm		p/d 34 cm GB5MBAP21	GB5MCAP21





EPIFANO BIFRONTE BASE | EPIFANO DOUBLE-SIDED STARTER BAY

		L/W 74 cm	L/W 92 cm
EPIFANO BASE 3+3 RIPIANI + TOP EPIFANO starter bay 3+3 shelves + top H 120 cm		p/d 63 cm GB5M10106	GB5MCAI23
EPIFANO BASE 4+4 RIPIANI + TOP EPIFANO starter bay 4+4 shelves + top H 150 cm		p/d 63 cm GB5M10102	GB5M10236
EPIFANO BASE 4+4 RIPIANI + TOP EPIFANO starter bay 4+4 shelves + top H 180 cm		p/d 63 cm GB5MBAG23	GB5MCAG23
EPIFANO BASE 5+5 RIPIANI + TOP EPIFANO starter bay 5+5 shelves + top H 210 cm		p/d 63 cm GB5M10082	GB5MCAP23

EPIFANO MONOFRONTE COMPONIBILE | EPIFANO SINGLE-SIDED ADD-ON BAY

		L/W 71,5 cm	L/W 89,5 cm
EPIFANO COMPONIBILE 3 RIPIANI + TOP EPIFANO add-on bay 3 shelves + top H 90 cm		p/d 34 cm GB5M10250	GB5M10247
EPIFANO COMPONIBILE 3 RIPIANI + TOP EPIFANO add-on bay 3 shelves + top H 120 cm		p/d 34 cm GB5MBAI22	GB5MCAI22
EPIFANO BASE 4 RIPIANI + TOP EPIFANO add-on bay 4 shelves + top H 150 cm		p/d 34 cm GB5M10258	GB5M10237
EPIFANO COMPONIBILE 4 RIPIANI + TOP EPIFANO add-on bay 4 shelves + top H 180 cm		p/d 34 cm GB5M10070	GB5MCAG22
EPIFANO COMPONIBILE 5 RIPIANI + TOP EPIFANO add-on bay 5 shelves + top H 210 cm		p/d 34 cm GB5MBAP22	GB5MCAP22

EPIFANO BIFRONTE COMPONIBILE | EPIFANO DOUBLE-SIDED ADD-ON BAY

		L/W 71,5 cm	L/W 89,5 cm
EPIFANO COMPONIBILE 3+3 RIPIANI + TOP EPIFANO add-on bay 3+3 shelves + top H 120 cm		p/d 63 cm GB5M10107	GB5MCAI24
EPIFANO COMPONIBILE 4+4 RIPIANI + TOP EPIFANO add-on bay 4+4 shelves + top H 150 cm		p/d 63 cm GB5M10274	GB5M10022
EPIFANO COMPONIBILE 4+4 RIPIANI + TOP EPIFANO add-on bay 4+4 shelves + top H 180 cm		p/d 63 cm GB5M10100	GB5MCAG24
EPIFANO COMPONIBILE 5+5 RIPIANI + TOP EPIFANO add-on bay 5+5 shelves + top H 210 cm		p/d 63 cm GB5M10084	GB5MCAP24

ABACHI SCAFFALI, CARTELLE COLORI

SHELVES CODIFICATION,
COLOR CHARTS

RIPIANO IN METALLO | METAL SHELF

P/D 26 cm

RIPIANO CON BORDO FERMALIBRO E KIT*

shelf with front book stop
and accessory kit*



l/w 70 cm
l/w 90 cm

GB5M10075
GB5RCA002

*KIT composto da n.4 reggipiani in zama

ACCESSORY KIT includes n.4 shelf supports

ANTE | DOORS

L/W 92 cm

ANTE IN LEGNO

wooden doors



h 88 cm
h 204 cm

GB5M10034
GB5M10131

ANTE IN CRISTALLO

plate glass doors



h 88 cm
h 204 cm

GB5M10035
GB5M10037

FIANCO ESPOSITORE | SIDE DISPLAY

P/D 63 cm

FIANCO ESPOSITORE

side display



h 120 cm
h 150 cm
h 180 cm
h 210 cm

GB5M10239
GB5M10240
GB5M10241
GB5M10242

ZOCCOLO E RUOTE | KICK PLATE AND CASTORS



ZOCCOLO FRONTALE

front kick plate

69 cm
87 cm

GB5M10040
GB5M10039



SISTEMA CARRELLATO*

castor set*

63 cm

GB5M10047

*disponibile solo per scaffali bifronti
L 92 cm

available for double-sided bays cm W92 only

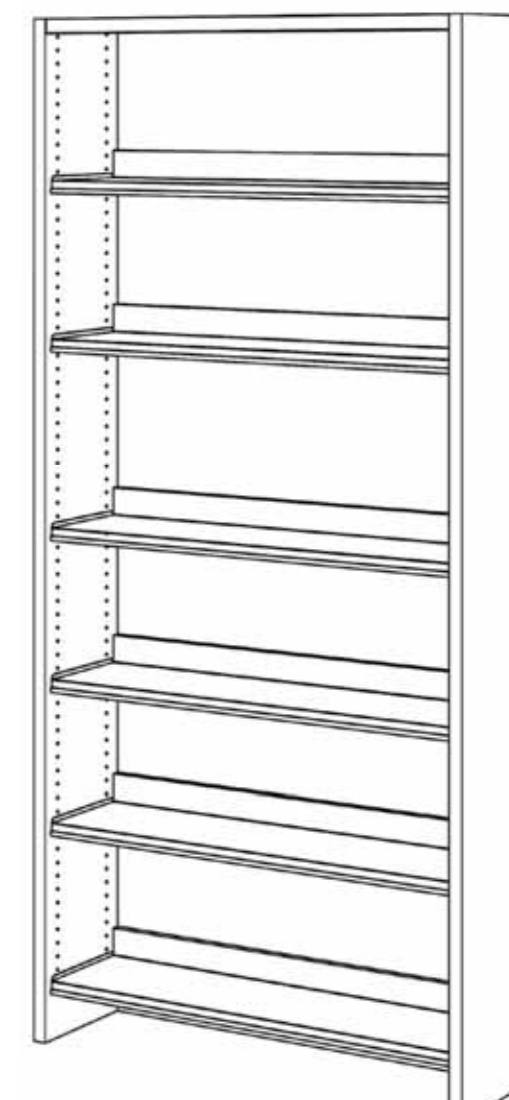

CERTIFICAZIONI

CERTIFICATIONS

EN 16121-2013 + A1-2017

Mobili contenitori non domestici – Requisiti per la sicurezza, la resistenza, la durabilità e la stabilità

Non-domestic storage furniture – Requirements for safety, strength, durability and stability

EN 16122-2012 + AC-2015

Mobili contenitori domestici e non domestici – Metodi di prova per la determinazione di resistenza, durabilità e stabilità

Domestic and non-domestic storage furniture – Test methods for the determination of strength, durability and stability

ABACHI SCAFFALI,
CARTELLE
COLORI

SHELVES CODIFICATION,
COLOR CHARTS

CARTELLE COLORI
COLOR CHARTS

BANCO ACCOGLIENZA | RECEPTION DESK

struttura
structure



accessori
accessories



LOCKERS, SISTEMA 618 – CONTENITORI E ACCESSORI | LOCKERS, SYSTEM 618 – CABINETS AND ACCESSORIES

cassa
main structure



ante, accessori
doors, accessories



PUNTO E VIRGOLA
PUNTO E VIRGOLA



struttura metallica
metal base

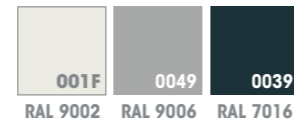

nicchie, microspazio
niches, microspace



ESPOSITORI METALLICI, GAM BOX | METAL DISPLAYS, GAM BOX

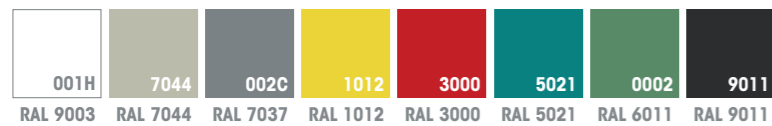

CARRELLO PORTALIBRI A 4 RIPIANI | BOOK TROLLEY WITH 4 INCLINED SHELVES

COMBINAZIONE 01
COMBINATION 01

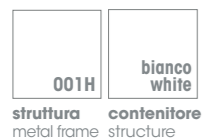

COMBINAZIONE 02
COMBINATION 02

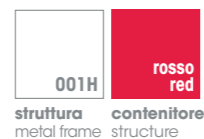

COMBINAZIONE 03
COMBINATION 03

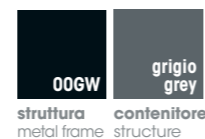

CARRELLO PORTALIBRI A 3 RIPIANI | BOOK TROLLEY WITH 3 INCLINED METAL SHELVES

fianchi
sides



ripiani
shelves

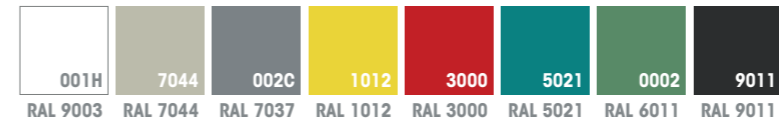

BOX RESTITUZIONE LIBRI DA INTERNO | INDOOR BOOK RETURN BOX

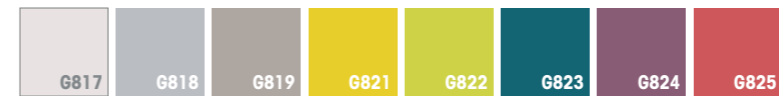

BOX RESTITUZIONE LIBRI DA ESTERNO | OUTDOOR BOOK RETURN BOX



SISTEMA PANCHE ELLE, BUKSOFÀ | ELLE BENCHES, BUKSOFÀ

sistema panche ELLE
ELLE benches



BUKSOFÀ
BUKSOFÀ



ABACHI SCAFFALI, CARTELLE COLORI

SHELVES CODIFICATION,
COLOR CHARTS

SISTEMA MODULAR | MODULAR SHELVING SYSTEM

pannelli laterali, accessori SPECIAL
end panels, SPECIAL accessories



scaffale MODULAR, ripiani, pannelli laterali in metallo forato, accessori metallici
MODULAR metal shelves, perforated metal end panels, metal accessories

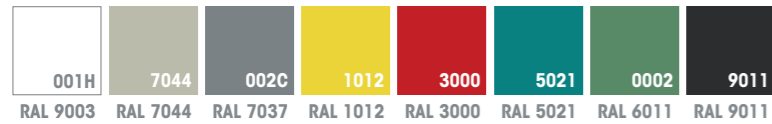

SISTEMA EPIFANO | EPIFANO SHELVING SYSTEM

fianchi
end panels



ripiani
shelves

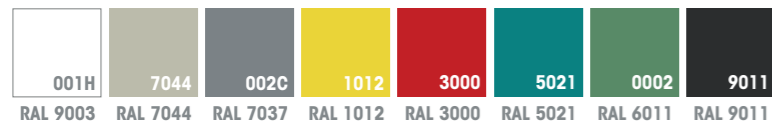

SISTEMA INSERT | INSERT SYSTEM

scaffale
shelf



accessori in nobilitato
MFC accessories



accessori in laccato e nobilitato
lacquered and MFC accessories



ESPOSITORI A SCHEDARIO, SU RUOTE, A SCALARE | BOOK BROWSERS

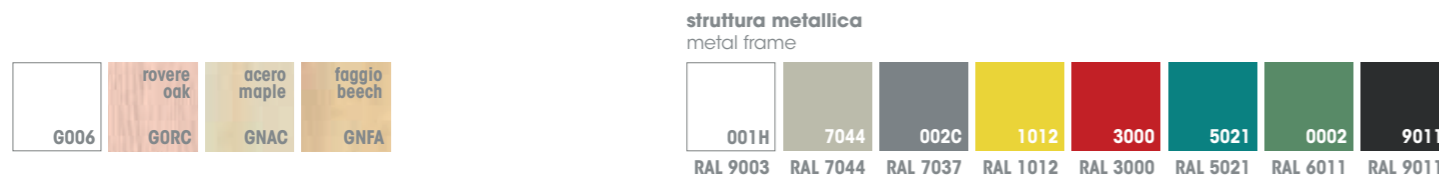

PANNELLI FONOASSORBENTI | SOUND-ABSORBING PANELS



PEDANE, GRADONI, PANCHE | STAGES, TWO-TIERED SEATING, BENCHES

pedane
stages



gradoni
two-tiered seating



panche
benches



ESAGONI | HEXAGONS

struttura
structure



fondo
bottom



SISTEMA 06 – POUF, SISTEMA 618 – POUF, POUF, MORBIDI | SYSTEM 06 – POUFS, SYSTEM 618 – POUFS, POUFS, SOFT FURNISHINGS

morbidi
padding

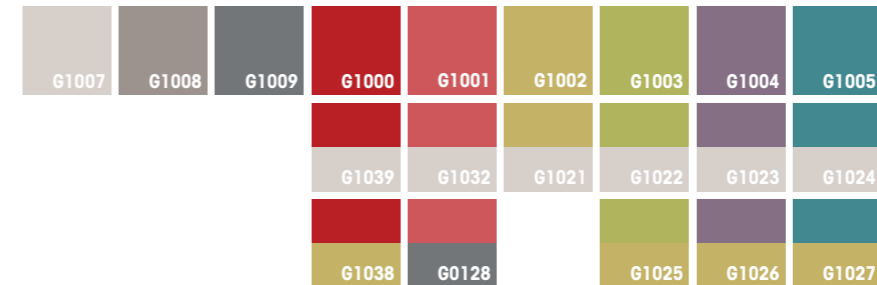

gambe SISTEMA 06 – pouf
SYSTEM 06 – POUFS feet



struttura metallica SISTEMA 618 – pouf
SYSTEM 06 – POUFS metal base

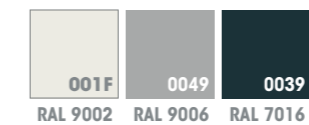

TAPPETI | CARPETS

treford
treford

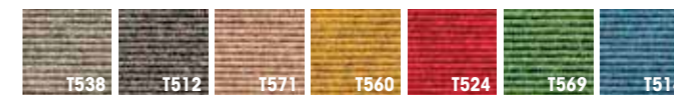

moquette
moquette

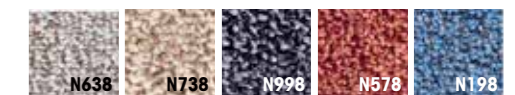

ACCESSORI SISTEMA PARETE | ACCESSORIES FOR WALL SYSTEM



ABACHI SCAFFALI, CARTELLE COLORI

SHELVES CODIFICATION,
COLOR CHARTS

KALEOX | KALEOX



TAVOLINO KENSHO | KENSHO SMALL TABLE



IDEA+, POP-UP, TAVOLI RIUNIONE, TAVOLO TONDO CON GAMBONE | IDEA+, POP UP, MEETING ROOM TABLES, ROUND TABLE WITH CENTRAL LEG

piano in melaminico
MFC tabletop

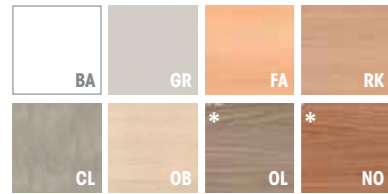

*finitura unica per tavolo riunione singolo
con struttura cubo
single finish for meeting table with cube structure

struttura metallica
metal frame



TAVOLI ALTO | HIGH TABLES

piano di lavoro
table top



*finitura su richiesta con variazione di prezzo
finish on demand at extra cost

struttura metallica
metal frame

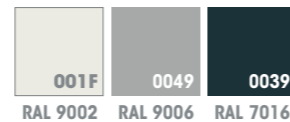

KAPIO | KAPIO



CONSOLE, PANNELLO DIVISORIO | CONSOLE, PARTITION PANEL



POSTAZIONI OPAC | OPAC WORKSTATION

piano di lavoro, fianchi
table top, sides



struttura metallica
metal frame

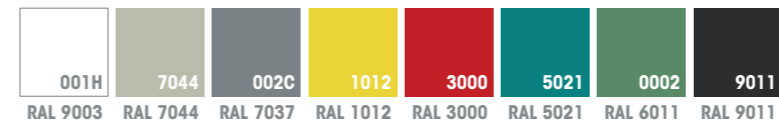

TAVOLI STUDIO | STUDY TABLES

piano di lavoro, fianchi
table top, sides



contenitore soprapiano
countertop unit



struttura metallica
metal frame



SISTEMA 618 – TAVOLI | SYSTEM 618 – TABLES

piano di lavoro
table top



*finitura su richiesta con variazione di prezzo
finish on demand at extra cost

struttura metallica
metal frame

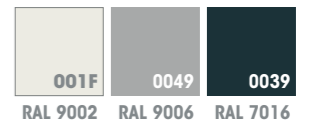

SISTEMA 06 – TAVOLI | SYSTEM 06 – TABLES

piano di lavoro
table top



gambe
legs



TAVOLO GIAPPONESE | JAPANESE TABLE



ABACHI SCAFFALI, CARTELLE COLORI

SHELVES CODIFICATION,
COLOR CHARTS

KUBIX, KARMA, KORIU MESH | KUBIX, KARMA, KORIU MESH

ecopelle
eco-leather



tessuto
fabric

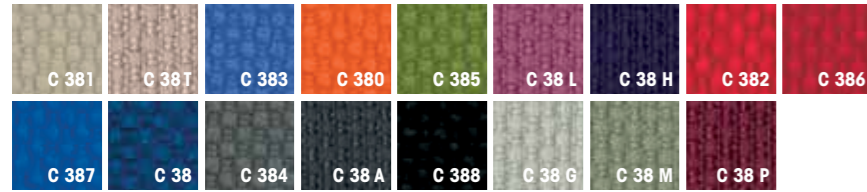

schienale in rete colore nero
per KARMA e KORIU MESH
black mesh backrest
for KARMA and KORIU MESH

KUARK | KUARK

scocca in polipropilene
polypropylene shell



cuscino
cushion



TONA, MIT | TONA, MIT

ecopelle CALLAO
eco-leather CALLAO



tessuto MORELIA
fabric MORELIA



tessuto MANAGUA
fabric MANAGUA



KENDO, KONTEX, KENSHO, KUAD | KENDO, KONTEX, KENSHO, KUAD

ecopelle
eco-leather



MANTRA | MANTRA

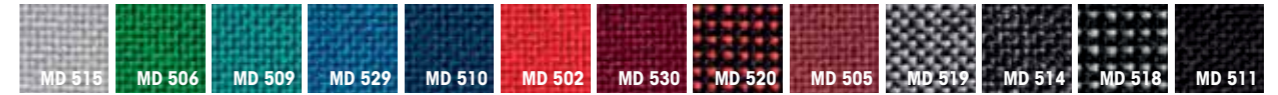

POINT, POINT Q | POINT, POINT Q

ecopelle
eco-leather

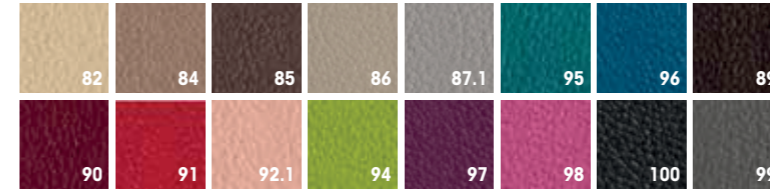

tessuto
fabric



TRIO | TRIO

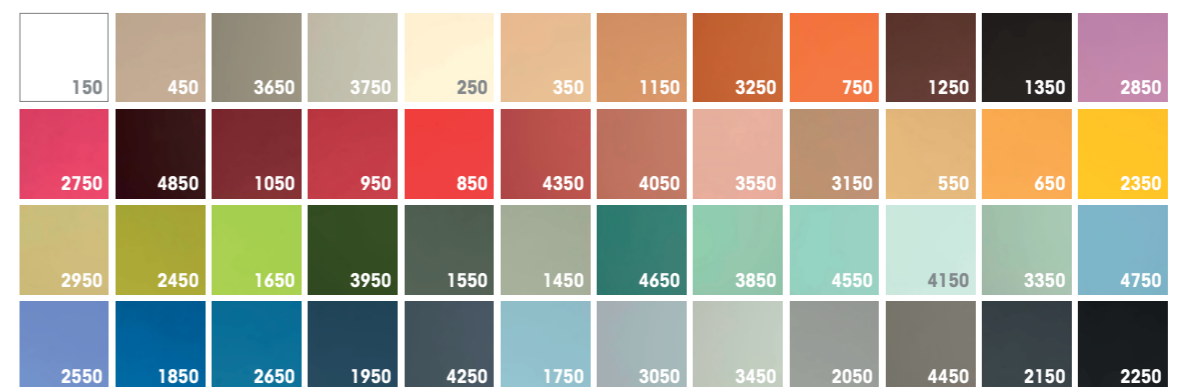

ABACHI SCAFFALI, CARTELLE COLORI

SHELVES CODIFICATION,
COLOR CHARTS

KALEA | KALEA

scocca in polipropilene
polypropylene shell



**omologazione al fuoco classe 1
con sovrapprezzo per colore crema**
class 1 fire homologation
at extra cost for cream color

ecopelle
eco-leather



tessuto
fabric



CLOP | CLOP

scocca in polipropilene
polypropylene shell



cuscino
cushion



KLIA | KLIA



**omologazione al fuoco classe 1
con sovrapprezzo per colore crema**
class 1 fire homologation
at extra cost for cream color

KICCA | KICCA

scocca in polipropilene
polypropylene shell



**omologazione al fuoco classe 1
con sovrapprezzo per colore crema e grigio**
class 1 fire homologation
at extra cost for cream and grey color

KICCA PLUS | KICCA PLUS

ecopelle
eco leather



G-TYPE | G-TYPE

scocca plastica
plastic shell



*** disponibile anche nella versione con scocca in plastica riciclata
e con scocca ignifuga CL1**
also available with recycled plastic shell and with CL1 fireproof shell

scocca in legno
wooden shell



struttura metallica
metal frame

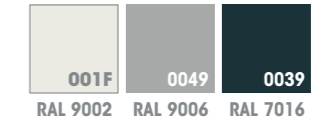

POSTURA | POSTURA



TURIN | TURIN

scocca in legno
wooden shell

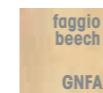

struttura metallica
metal frame

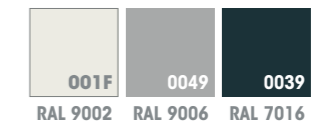

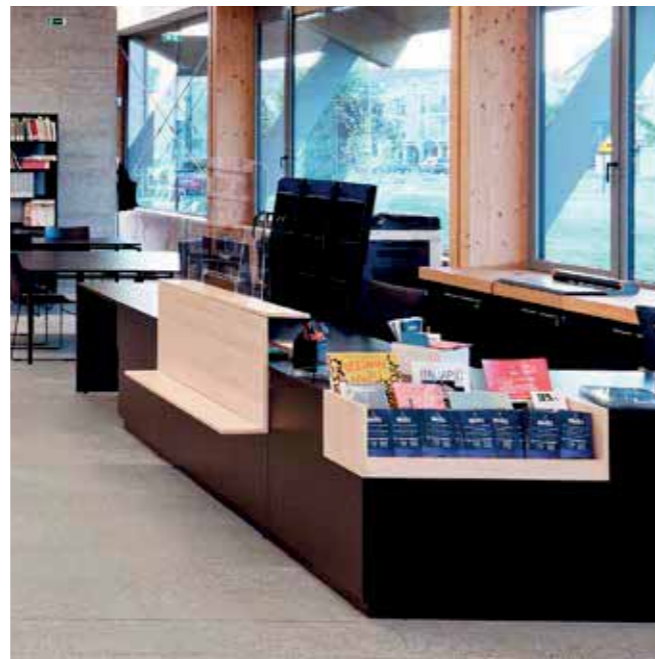

GAM BIBLIOTECHE

GAM LIBRARIES





Biblioteca LAC Libri Arte e Cultura a Baselga di Piné, Trento

Library LAC Libri Arte e cultura in Baselga di Piné, Trento

immagini: Giovanni Marangon



Biblioteca Carlo Mosso del conservatorio Antonio Vivaldi ad Alessandria

Carlo Mosso Library – Antonio Vivaldi conservatory in Alessandria

immagini: Giovanni Marangon

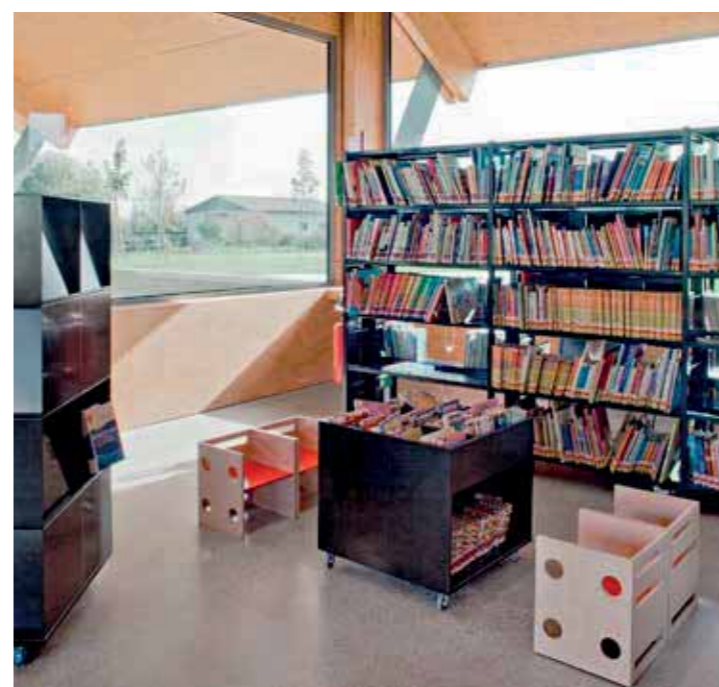
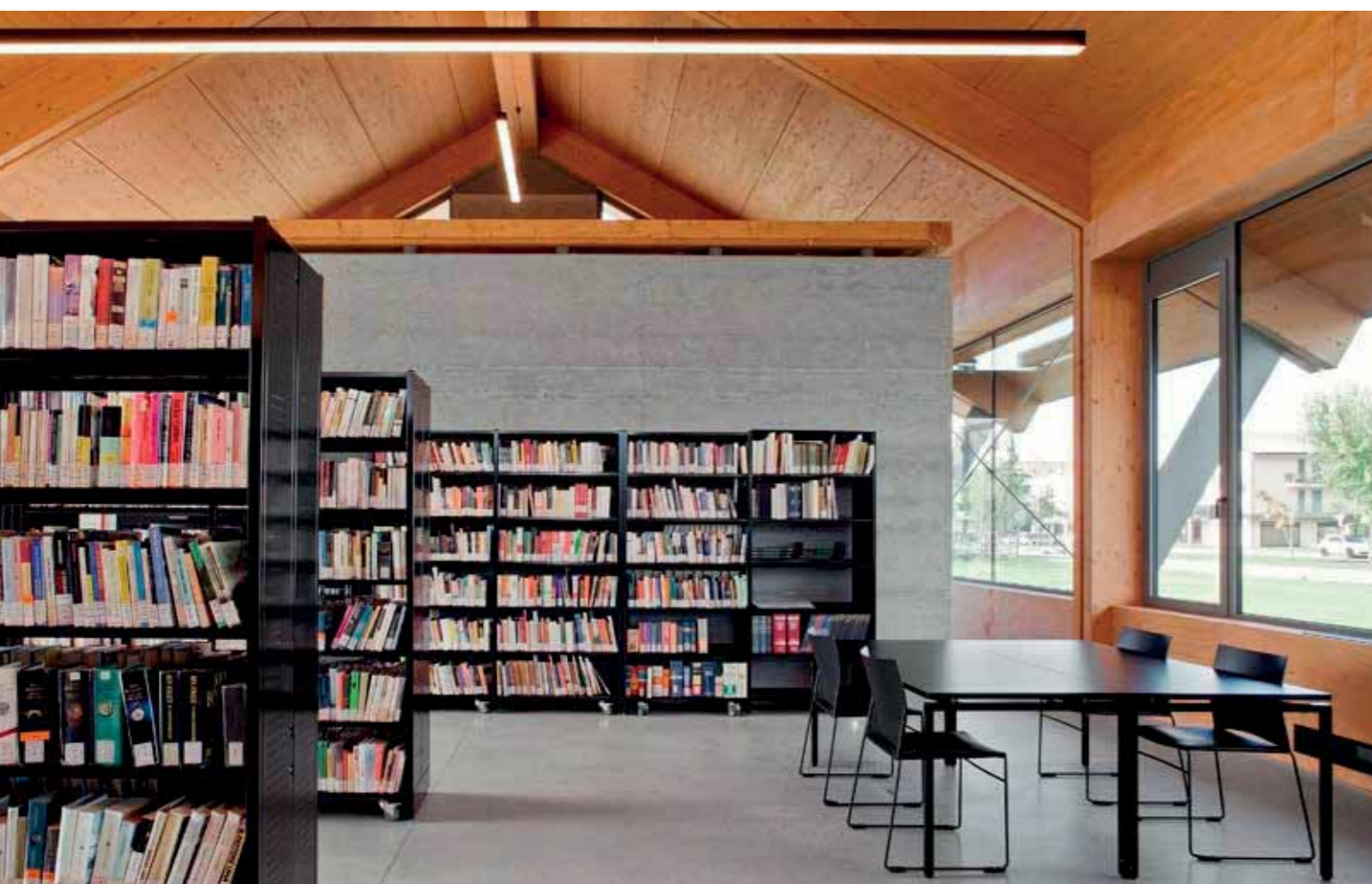

Biblioteca Biblio a Veggiano, Padova

Biblio Library in Veggiano, Padova

immagini: MIDEarchitetti



Biblioteca Palazzo Baccin Bilbliomuseo a Nove, Vicenza

Bibliomuseo Palazzo Baccin Library in Nove, Vicenza

immagini: Claudio Battisti, Mariano Tafferini



Biblioteca G. Gerosa Brichetto a Peschiera Borromeo, Milano

G. Gerosa Brichetto Library in Peschiera Borromeo, Milano

immagini: Claudio Battisti

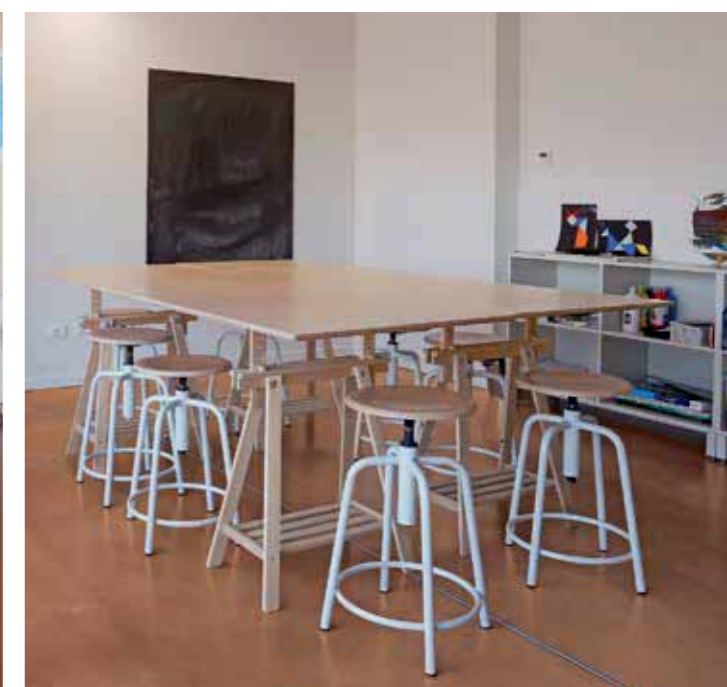

Mantua Farm School a Curtatone, Mantova

Mantua Farm School in Curtatone, Mantova

immagini: Claudio Battisti, Giovanni Marangon



Biblioteca Civica Junior a Parma

Junior Civic Library in Parma

immagini: Claudio Battisti, Giovanni Marangon



Biblioteca Sovracomunale a Pergine Valsugana e Valle del Fersina, Trento

Council Library in Pergine Valsugana e Valle del Fersina, Trento

immagini: Alterstudio Partners, Gianluca Perottoni Architetto

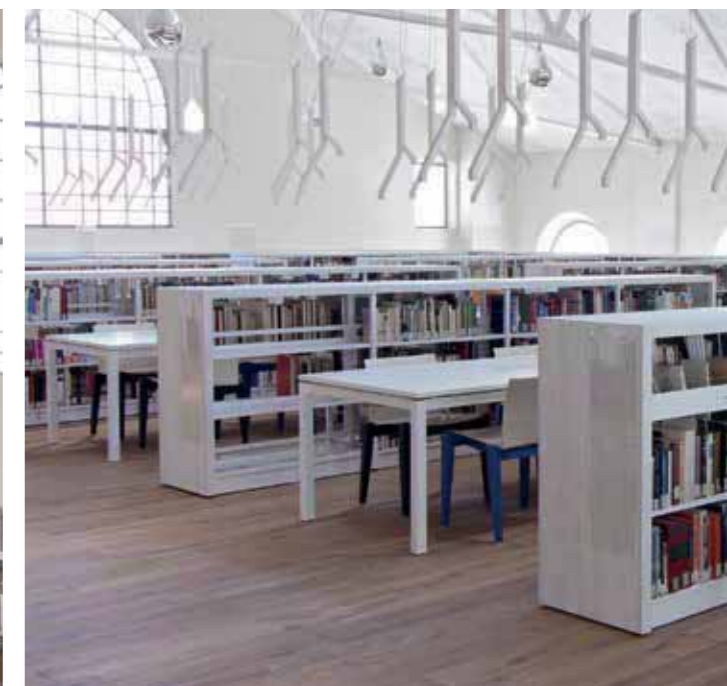

Biblioteca P.M. Beghi a La Spezia

P.M. Beghi Library in La Spezia

immagini: Claudio Battisti, Gianluca Giubilei



Biblioteca P.M. Beghi a La Spezia

P.M. Beghi Library in La Spezia

immagini: Claudio Battisti, Gianluca Giubilei



Biblioteca Beato Pellegrino di Studi Letterari, Linguistici, Pedagogici e dello Spettacolo presso l'Università degli Studi di Padova, Padova

Beato Pellegrino University Library c/o Università degli Studi di Padova, Padova

immagini: Ruben Verdi Architetto



Biblioteca Beato Pellegrino di Studi Letterari, Linguistici, Pedagogici e dello Spettacolo presso l'Università degli Studi di Padova, Padova

Beato Pellegrino University Library c/o Università degli Studi di Padova, Padova

immagini: Ruben Verdi Architetto



Biblioteca A. Rosmini a Toscolano Maderno, Brescia

A. Rosmini Library in Toscolano Maderno, Brescia

immagini: Gianluca Giubilei



Biblioteca Mario Luzi a San Miniato, Pisa

Mario Luzi Library in San Miniato, Pisa

immagini: Gianluca Giubilei



Biblioteca Comunale Renato Fucini a Empoli, Firenze

Renato Fucini Council Library in Empoli, Firenze

immagini: Gianluca Giubilei

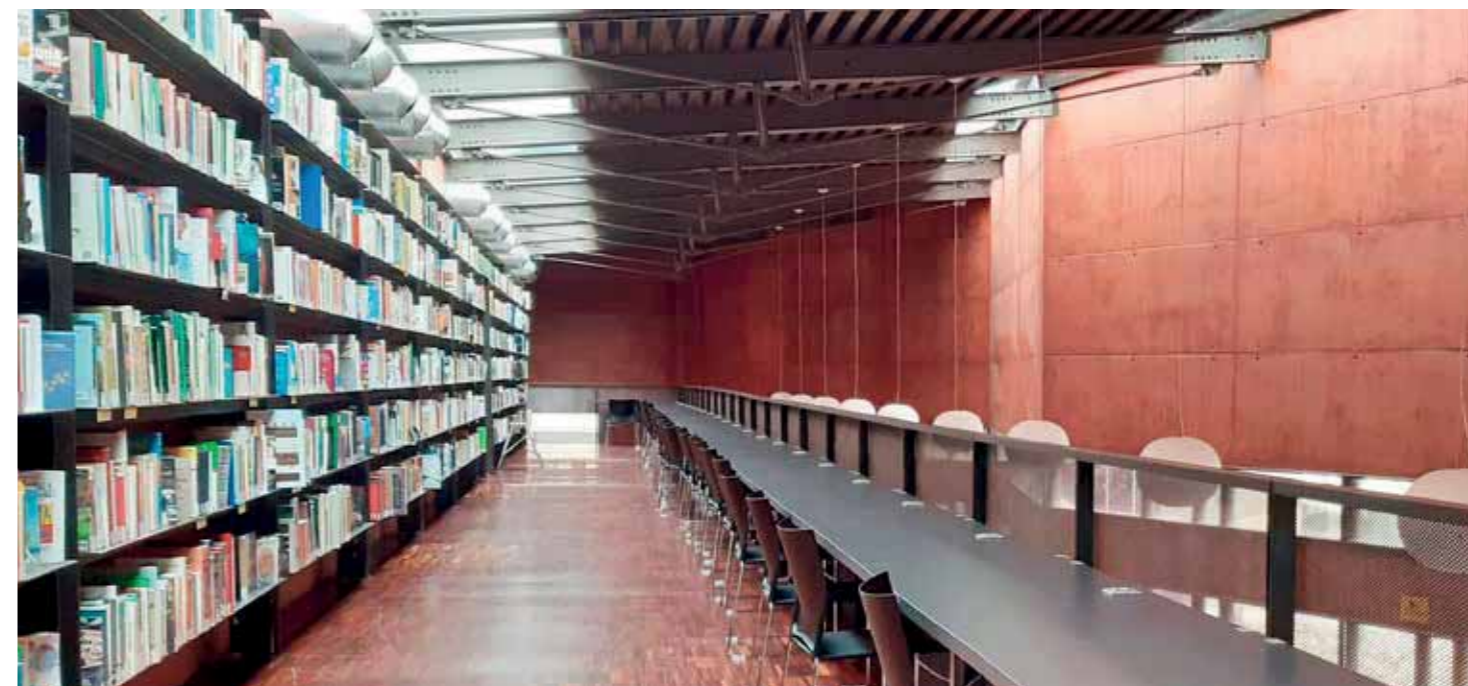

Biblioteca Rita Levi Montalcini a Curno, Bergamo

Rita Levi Montalcini Library in Curno, Bergamo

immagini: Claudio Battisti



GAM è anche SCUOLE
GAM also means SCHOOLS



GAM è anche NIDI E SCUOLE D'INFANZIA
GAM also means NURSERIES
AND KINDERGARTENS



GAM è anche MATERIALI MONTESSORI
GAM also means MONTESSORI
MATERIALS



DESIGN GAM
GAM DESIGN



CERTIFICAZIONI
CERTIFICATIONS



GAM è anche SCUOLE

GAM also means SCHOOLS



GAM è protagonista del rinnovamento della scuola italiana. Progetta allestimenti e arredi che interpretano nuovi modi di apprendere e insegnare. GAM realizza scuole di qualità su scala internazionale.

GAM is the protagonist of the renewal of the Italian school. He designs installations and furnishings that interpret new ways of learning and teaching. GAM builds quality schools on an international scale.

GAM è anche NIDI E SCUOLE D'INFANZIA
 GAM also means NURSERIES AND KINDERGARTENS



GAM arreda spazi che accolgono i bambini e sostengono la loro crescita. Da decenni contribuisce alla costruzione di una moderna cultura dei servizi per l'infanzia. GAM disegna e produce arredi e oggetti divenuti standard universalmente riconosciuti e molto imitati.

GAM furnishes environments that welcome children and support their growth. For decades it has contributed to the construction of a modern culture of childcare services. GAM designs and produces furnishings that have become universally recognized and much imitated.

GAM è anche MATERIALE MONTESSORI

GAM also means MONTESSORI MATERIALS

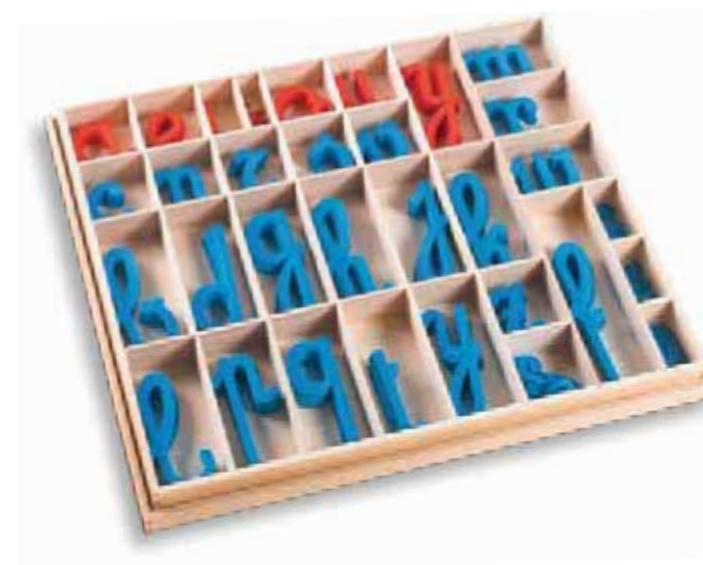
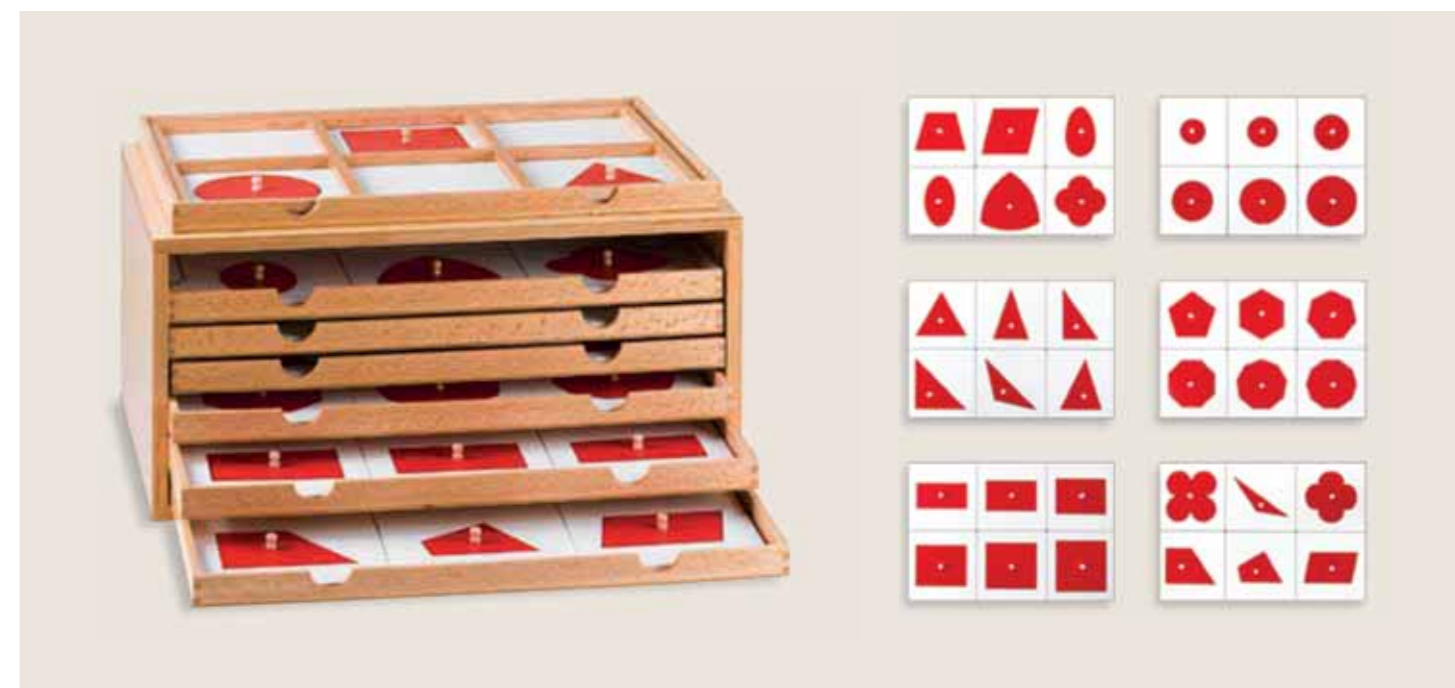

GAM ha radici nella storia della pedagogia. Nasce dall'antica falegnameria della città di Gonzaga che ha prodotto i primi materiali educativi e arredi disegnati da Maria Montessori. GAM è l'unica azienda italiana e una delle quattro al mondo ad avere l'approvazione ufficiale dell'AMI, Association Montessori Internationale.

GAM is deeply rooted in the history of pedagogy. It was born from the old carpentry shop of the city of Gonzaga which produced the first educational materials and furnishings designed by Maria Montessori. GAM is the only Italian company - and one of the four in the world - to have obtained the official approval from AMI, the Montessori International Association.

DESIGN GAM
GAM DESIGN

Ogni biblioteca davvero moderna, grande o piccola, è tante cose insieme: spazio di cultura, centro di una comunità, luogo di identità, ambiente aperto per incontri, eventi, iniziative.

Per GAM ogni biblioteca è un nuovo progetto. Un progetto fatto rapporto con il contesto, di ascolto delle esigenze, disegno accurato degli spazi, cura dei particolari.



Every truly modern library - big or small - is so many things together: a cultural space, a community center, a place of identity, an open environment for meetings, events, initiatives.

Every library is a new project to GAM. A project carried out in relation to the context by listening to the users' needs, accurate design of the spaces, attention to detail.

CERTIFICAZIONI CERTIFICATIONS

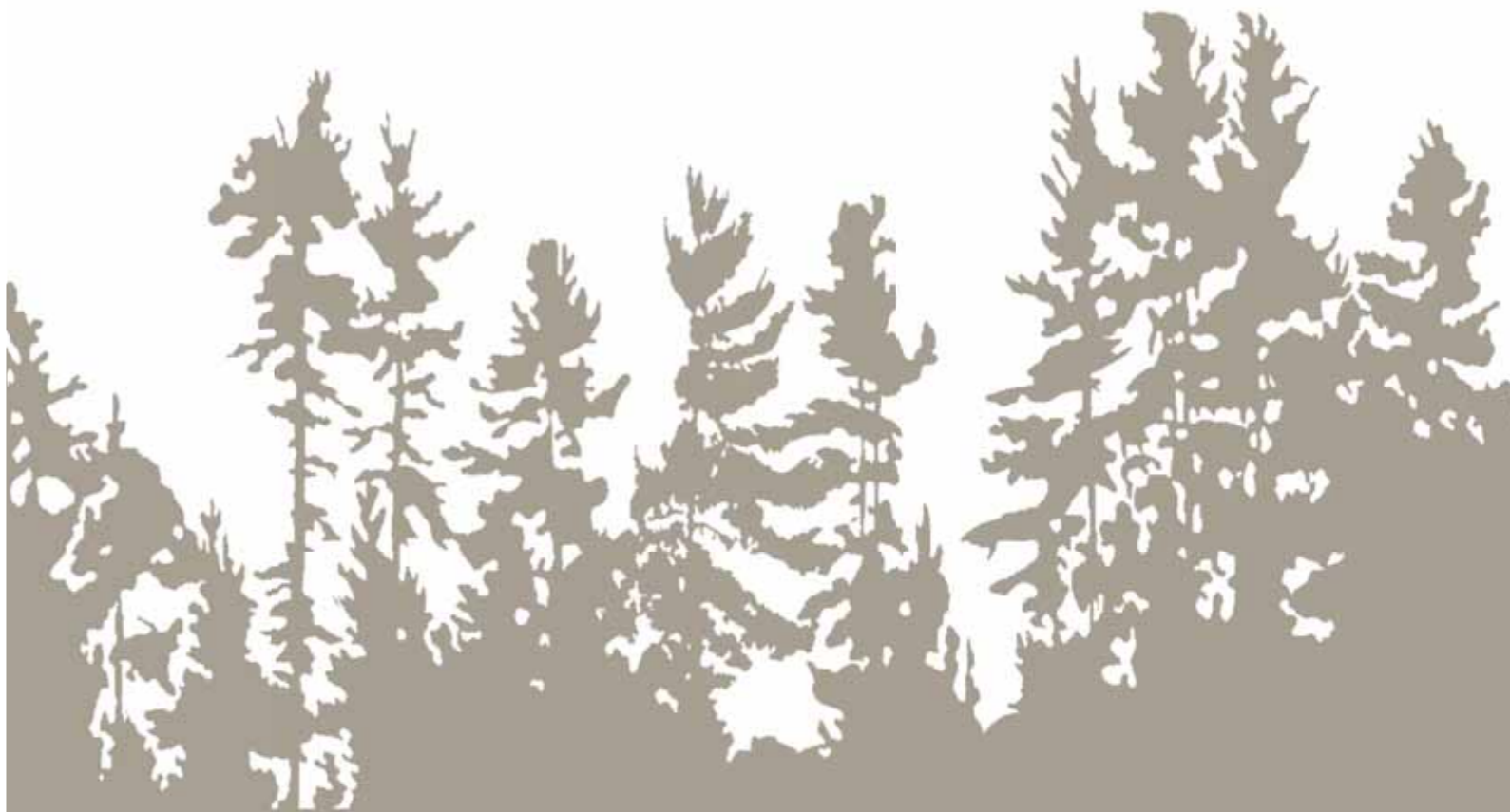

I prodotti GAM sono conformi alle norme tecniche del settore. Sono testati per sicurezza, resistenza e non tossicità. Vernici e coloranti sono atossici, contenuto di formaldeide in classe E1, imbottiti in classe di reazione al fuoco 1IM, su richiesta arredi lignei in classe 1. I prodotti GAM sono conformi ai CAM (Criteri Ambientali Minimi).

All GAM products comply with the technical standards of the sector. They are tested for safety, resistance, and non-toxicity. Paints and colors are non-toxic, class E1 formaldehyde content, 1IM fire rating upholstery; class 1 wooden furnishing on request. GAM products comply with CAM (minimum environmental criteria).



Product design, art direction, copywriting – **Giovanni Fumagalli**
cc91 design & research

Graphic design – **Simona Malizia**

Content management – **Anna Prandi, Andrea Maiocchi**

**ARREDI PER SCUOLE
E SERVIZI PER L'INFANZIA
ARREDI PER BIBLIOTECHE
MATERIALI MONTESSORI
EARLY-YEARS FURNITURE
SCHOOL FURNITURE
LIBRARY FURNITURE
MONTESSORI MATERIALS**

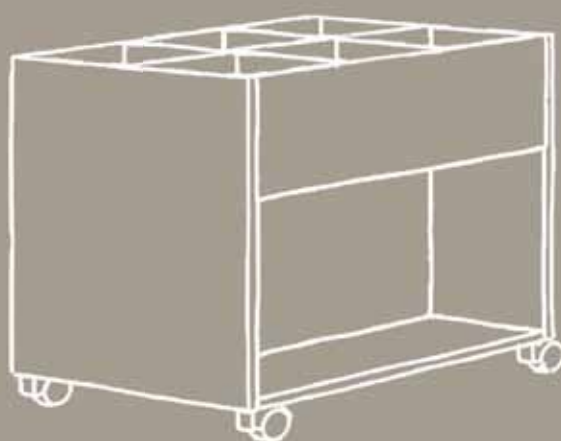
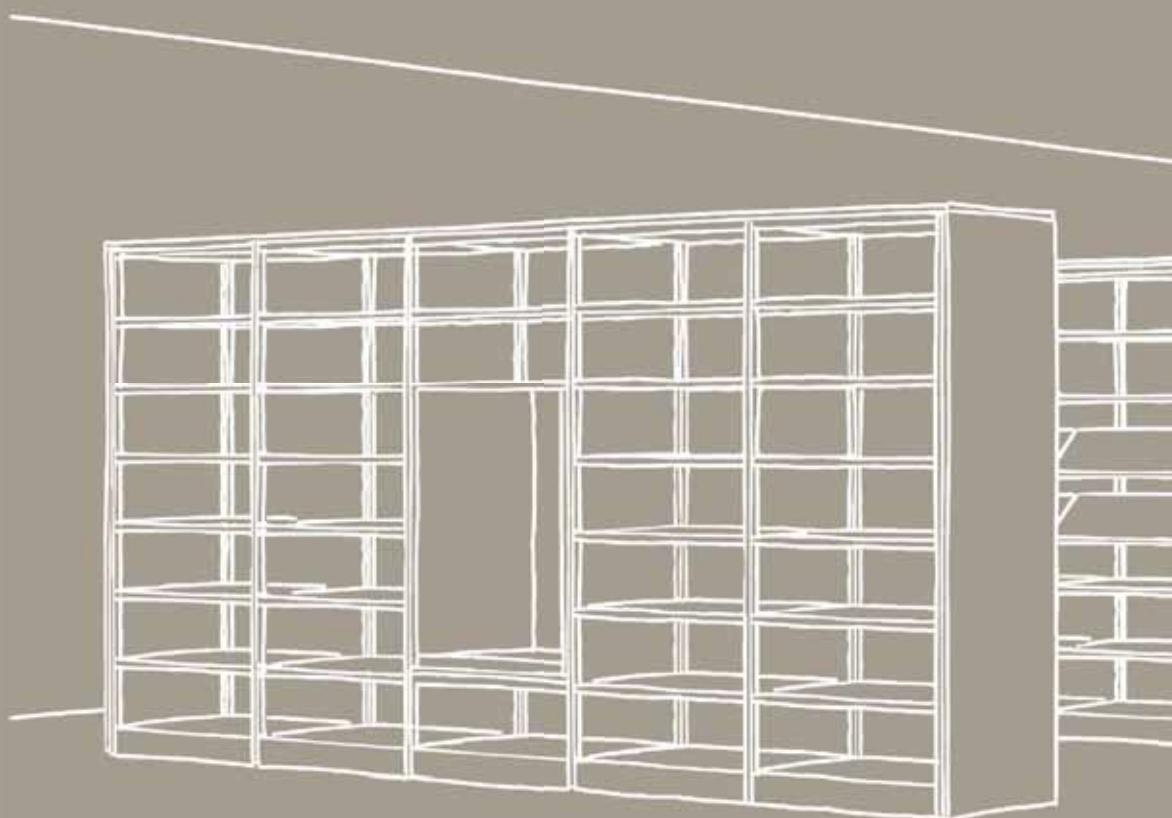

GAM GonzagArredi Montessori Srl
46023 Gonzaga (MN) - Italy
Tel. +39 0376 518 200 - Fax +39 0376 528 127
www.gonzagarredi.com - info@gonzagarredi.it